

## MHT100 A/V System Controller



Manufactured under license from Dolby Laboratories, “Dolby”, “Pro Logic” and the double-D symbol are registered trademark of Dolby Laboratories, Inc. **SRS** and **(C)** symbol are trademarks of SRS Labs, Inc. **CS-3X** Technology is incorporated under license from SRS labs, Inc. “DTS”, “Digital Surround”, and “Coherent Acoustics” are registered trademark of DTS Technology, LLC. and manufactured under license from DTS Technology LLC.

## MHT100

The lightning flash with arrowhead, within an equilateral triangle, is intended to alert the user to the presence of uninsulated "dangerous voltage" within the product's enclosure that may be of sufficient magnitude to constitute a risk of electric shock to persons.



AVIS RISQUE DE CHOC ELECTRIQUE - NE PAS OUVRIR.

The exclamation point within an equilateral triangle is intended to alert the user to the presence of important operating and maintenance (servicing) instructions in the literature accompanying the appliance.

**WARNING - TO REDUCE RISK OF FIRE OR ELECTRICAL SHOCK, DO NOT EXPOSE THIS EQUIPMENT TO RAIN OR MOISTURE.**

**NO USER-SERVICEABLE PARTS INSIDE. REFER SERVICING TO QUALIFIED PERSONNEL.**

To prevent the risk of electric shock, do not remove cover or back. No user serviceable parts inside.

## IMPORTANT SAFETY INSTRUCTIONS!

**PLEASE READ THEM BEFORE OPERATING THIS EQUIPMENT.**

### General:

1. Read these instructions.
2. Keep these instructions.
3. Heed all warnings.
4. Follow all instructions.
5. **Warning: To reduce risk of fire or electrical shock, do not expose this equipment to rain or moisture. This unit is capable of producing high sound pressure levels. Continued exposure to high sound pressure levels can cause permanent hearing impairment or loss. User caution is advised and ear protection is recommended when playing at high volumes.**
6. **Caution: to prevent electrical shock do not use this (polarized) plug with an extension cord, receptacle or other outlet unless the blades can be fully inserted to prevent blade exposure.**  
**Attention: pour prevenir les chocs electriques pas utiliser cette fiche polarisee avec un prolongateur, une prise de courant ou un autre sortie de courant, sauf si les lames peuvent etre inserees afond ans en laisser aucune partie a decouvert.**
7. Unplug this equipment during lightning storms or when unused for long periods of time.
8. Only use attachments/accessories specified by the manufacturer.

### Installation:

9. The equipment shall be installed near the AC Socket Outlet and the disconnect device shall be easily accessible.
10. Do not block any ventilation openings. Install in accordance with the manufacturer's instructions.
11. Do not install near any heat sources such as radiators, heat registers, stoves, or other equipment (including amplifiers) that produce heat.
12. Do not use this equipment near water.
13. Do not expose this equipment to dripping or splashing and ensure that no objects filled with liquids, such as vases, are placed on the equipment.
14. Use only with the cart, stand, tripod, bracket, or table specified by the manufacturer, or sold with the equipment. When a cart is used, use caution when moving the cart/equipment combination to avoid injury from tip-over.



### Connection:

15. Connect this equipment only to the type of AC power source as marked on the unit.
16. Protect the power cord from being walked on or pinched particularly at plugs, convenience receptacles, and the point where they exit from the equipment.
17. Do not defeat the safety purpose of the polarized or grounding-type plug.

A polarized plug has two blades with one wider than the other. A grounding type plug has two blades and a third grounding prong. The wide blade or the third prong are provided for your safety. If the provided plug does not fit into your outlet, consult an electrician for replacement of the obsolete outlet.

18. Do not overload wall outlets, extension cords or integral convenience receptacles as this can result in a risk of fire or electric shock.
19. To completely disconnect this equipment from the AC Mains, disconnect the power supply cord plug from the AC receptacle.

#### Outdoor Antenna:

20. If an outdoor antenna is connected to the antenna terminal, be sure the antenna system is grounded to provide some protection against voltage surges and built up static charge. In the U.S.A., section 810 of the National Electrical Code, ANSI/NFPA No. 70-1978, provides information on the proper ground for the mast and supporting structure, ground for the lead-in wire to an antenna discharge unit, and size of ground conductors, location of antenna-discharge unit, connection to ground electrode. For ground wire:
  - A. Use No. 10 AWG (5.3 mm<sup>2</sup>) copper No. 8 AWG (8.4 mm<sup>2</sup>) aluminum, No. 17 AWG (1.0 mm<sup>2</sup>) cop- per-clad steel, bronze, or larger as ground wire.
  - B. Secure antenna lead-in and ground wires to the house with stand-off insulators spaced from 4 feet (1.2 meters) to 6 feet (1.83 meters) apart.
  - C. Mount antenna discharge unit as closely as possible to where lead-in enters house.

- D. Use jumper wire not smaller than No. 6 AWG (13.3 mm<sup>2</sup>) copper or equivalent when separate antenna grounding electrode is used.

#### Care of Equipment:

21. Clean only with a dry cloth.
22. Do not permit objects or liquids of any kind to be pushed, spilled and/or fall into the equipment through enclosure openings.
23. Unplug the power cord from the AC power outlet when left unused for a long period of time.

#### Repair of Equipment:

24. Refer all servicing to qualified service personnel. Servicing is required when the equipment has been damaged in any way, such as power-supply cord or plug is damaged, liquid has been spilled or objects have fallen into the equipment, the equipment has been exposed to rain or moisture, does not operate normally, or has been dropped.
25. Do not attempt to service beyond that described in the operating instructions. All other service should be referred to qualified service personnel.
26. When replacement parts are required, be sure the service technician has used replacement parts specified by McIntosh or have the same characteristics as the original part. Unauthorized substitutions may result in fire, electric shock, or other hazards.
27. Upon completion of any service or repairs to this product, ask the service technician to perform safety checks to determine that the product is in proper operating condition.

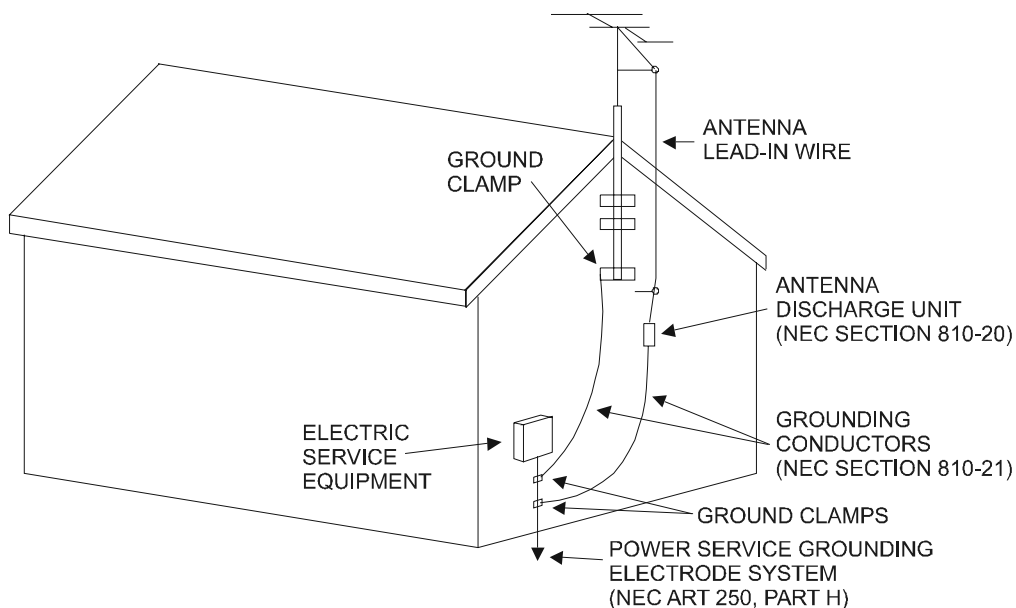

# McIntosh

## Thank You

Your decision to own this McIntosh MHT100 A/V System Controller ranks you at the very top among discriminating music listeners. You now have “The Best.” The McIntosh dedication to “Quality,” is assurance that you will receive many years of musical enjoyment from this unit.

Please take a short time to read the information in this manual. We want you to be as familiar as possible with all the features and functions of your new McIntosh.

## Please Take A Moment

The serial number, purchase date and McIntosh dealer name are important to you for possible insurance claim or future service. The spaces below have been provided for you to record that information:

**Serial Number:** \_\_\_\_\_

**Purchase Date:** \_\_\_\_\_

**Dealer Name:** \_\_\_\_\_

## Technical Assistance

If at any time you have questions about your McIntosh product, contact your McIntosh dealer who is familiar with your McIntosh equipment and any other brands that may be part of your system. If you or your dealer wish additional help concerning a suspected problem, you can receive technical assistance for all McIntosh products at:

McIntosh Laboratory, Inc.  
2 Chambers Street  
Binghamton, New York 13903  
Phone: 607-723-1545  
Fax: 607-723-3636

## Customer Service

If it is determined that your McIntosh product is in need of repair, you can return it to your dealer. You can also return it to the McIntosh Laboratory Service Department. For assistance on factory repair return procedure, contact the McIntosh Service Department at:

McIntosh Laboratory, Inc.  
2 Chambers Street  
Binghamton, New York 13903  
Phone: 607-723-3515  
Fax: 607-723-1917

## Table of Contents

Safety Instructions .....	2
Thank You .....	4
Please Take a Moment .....	4
Technical Assistance .....	4
Customer Service .....	4
Table of Contents .....	4
General Notes .....	5
Connector Information .....	6
Introduction .....	7
Performance Features .....	7
Dimensions .....	8
Installation .....	9
<b>Rear Panel Connections</b>	
Rear Panel Switch, Loudspeaker and Control Connections .....	10
Rear Panel Audio and Digital Connections .....	11
Rear Panel Video Connections .....	12
<b>How to Connect</b>	
Data and Power Control .....	13
Loudspeakers .....	14
Audio and Digital Components .....	16
Video Components .....	17
Zone B .....	18
<b>Front Panel Features</b>	
Controls, Sensor and Headphone Jack .....	19
Push-buttons and Switch .....	20
Displays .....	21
<b>Remote Control</b>	
Push-buttons .....	22
Operate by Remote Control .....	23
<b>Setup Mode</b>	
How to Operate the Setup Mode .....	24
Default Settings .....	25
How to Reset the MHT 100 .....	26
How to Adjust for Loudspeaker Size .....	27
How to Adjust for Loudspeaker Time Delay .....	28
How to Adjust for Loudspeaker Levels .....	29
How to Adjust the Subwoofer .....	32
How to Change Source Settings .....	34
How to Assign the Video Power Control .....	37
How to Change System Setup .....	38
<b>Operation</b>	
How to Operate the MHT100 .....	39
How to Make a Recording .....	42
How to Operate the Trim Mode .....	43
How to Operate the Surround Mode .....	45
How to Operate Zone B .....	46
<b>Additional Information</b>	
Preamplifier and Processors Specifications .....	48
Power Amplifier and General Specifications .....	49

**Table of Contents con't**

**TM1 AM/FM Tuner Module**

Introduction ..... 50  
 Performance Features ..... 50  
 MHT100 Rear Panel and RAA1 Top Panel  
     Antenna Connections ..... 51  
 How to Connect Antenna Components ..... 52  
**Tuner Setup**  
 How to Assign the Tuner Presets ..... 53  
**Tuner Operation**  
 How to Operate the Tuner ..... 55  
 How to Optimize AM Reception ..... 56  
**Additional Information**  
 Tuner Specifications ..... 57  
 Packing Instruction ..... 59

**General Notes**

1. When the MHT100 A/V System Controller is sold in North America, the TM1 AM/FM Tuner Module for Radio Station Reception is already installed. For MHT100 A/V System Controllers sold outside of North America the optional McIntosh TM1 AM/FM Tuner Module can be added. The TM1 is available from your McIntosh Dealer and can be installed at any time, usually while you wait. Refer to page 50 for additional information on the TM1.
2. The Main AC Power going to the MHT100 and any other McIntosh Component(s) should not be applied until all the system components are connected together. When the MHT100 and other McIntosh Components are in their Standby Power Off Mode the Microprocessor's Circuitry inside each component is active and communication is occurring between them. Failure to do so could result in malfunctioning of some or all of the system's normal operations.
3. Connecting Cables and Connectors are available from the McIntosh Parts Department:  
**Data and Power Control Cable Part No. 170-202**  
 Six foot, shielded 2 conductor, with 1/8 inch stereo mini phone plugs on each end.
4. For additional connection information, refer to the owner's manual(s) for any component(s) connected to the MHT100 A/V System Controller.
5. System Setup operations must be performed in the order they appear in the Main System Setup Menu as they are interactive.
6. The Zone A and Zone B IR Inputs, with 1/8 inch mini phone jacks, are configured for non-McIntosh IR sensors such as a Xantech Model 291-10. To avoid possible interaction, disable the MHT100 Front Panel Sensor using the built-in switch. The switch is recessed and available through an opening in the bottom cover. The opening is located behind and to the right of the Front Panel Sensor.
7. In order to hear bass frequencies below 80Hz, your system must include either a Subwoofer or Large Front Loudspeakers.

8. Zone B Audio is analog only, a Digital Audio Input Signal Source will not appear at the Zone B Audio Outputs. The source component Analog Outputs must also to be connected to the MHT100.
9. When an assigned Digital Input and a matching Analog Input are in use, the MHT100 automatically searches first for a Digital Signal. If no Digital Signal is sensed, it switches to the Analog Input.
10. Certain DVD or Laser Video Disc Players that are reproducing Digital DTS Signals into a MHT100 Digital Input, may only produce noise from their Analog Outputs at the same time. If Zone B is turned on and that same input is selected, that noise will be heard.
11. The MHT100 Input Source Name "DVD" is equivalent to "V-Aux" on some McIntosh Keypads, Remote Controls and Audio/Video Control Centers.
12. Up to four McIntosh Sensors or Keypads can be wired in parallel for both Zones A and B.
13. When a McIntosh WK-2 Keypad or a R649 Sensor is to be connected to the McIntosh MHT100 A/V Control Center that uses a RJ-45 Connector Plug instead of the "F" Coax Connector, connect the Center Conductor to Pin 1 and the Shield Conductor to Pin 2. Refer to the illustration below.

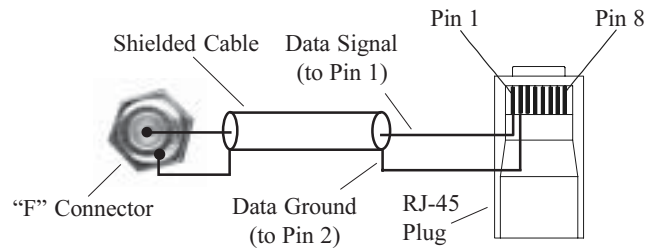

14. There are three types of Video Signals that can be connected to and selected by the MHT100; Composite, S-Video and Component. Zone A and B, VCR 1 and 2 have both Composite and S-Video Outputs; the Component Video Output is for Zone A only.
15. There are four Power Control Jacks on the MHT100 that can be used to switch on various electronic equipment. The jacks labeled ZONE A, ZONE B and ACCessory are designed for McIntosh Components. These three jacks supply a Positive going twelve volt Turn-On Signal. The jack labeled VIDEO supplies a twelve volt Turn-On Signal, that can be set for either Positive or Negative going voltage.
16. The On-Screen Setup Menu and Operational features are available at the MHT100 MON ZONE A Video Outputs (S-Video or Composite). There is no On-Screen Information present at the MHT100 Component Video Output.

## Connector Information

### Keypad Terminal Connector

To use a WK-3 or WK-4 keypad with the MHT100, connect the shield and four leads of a shielded 4 conductor cable to a RJ-45 Connector Plug, according to the numbers listed below. There is a numbered connector built-in to each keypad, which has a different pin out.

#### MHT100 RJ-45

1. Signal Data
2. Signal Data Gnd. and Cable Shield
3. N/C
4. Supply Voltage Negative
5. Supply Voltage Positive
6. N/C
7. N/C
8. N/C

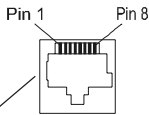

MHT100 Keypad Socket

#### WK-3 and WK-4 Keypad

1. Supply Voltage Positive
2. Supply Voltage Negative
3. Cable Shield
4. Signal Data
5. Signal Data Gnd.

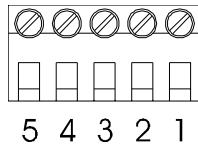

### RS232 DB9 Connector Pin Layout

- |                   |        |
|-------------------|--------|
| 1. N/C            | 6. N/C |
| 2. Data Out (TXD) | 7. N/C |
| 3. Data In (RXD)  | 8. N/C |
| 4. N/C            | 9. N/C |
| 5. Gnd.           |        |

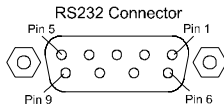

### RAA1 Connector

Connect the shield and two leads of a shielded 2 conductor cable to the supplied 5 Pin Terminal Connector Plug. Refer to the connection information on the top cover of the RAA1.

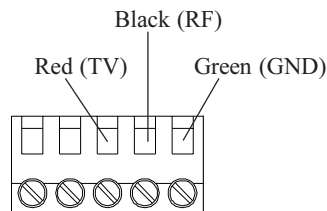

### Power Control Connector

The MHT100's Power Control Outputs provide a 12 volt signal. Use a 1/8 inch stereo mini phone plug to connect to the Power Control Input.

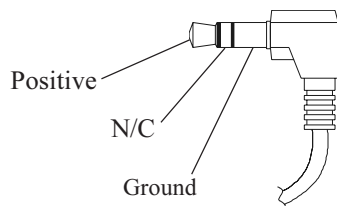

### Data and IR Port Connectors

The MHT100's Data Port Output provides Remote Control Signals and the IR Port allows for the connection of other brands IR Sensors. Use a 1/8 inch stereo mini phone plug to connect to the Data Port Inputs on McIntosh Source Units.

*Note: The MHT100 Rear Panel IR POWER Switch setting determines if twelve volt is present at the Zone A and B IR INPUTS.*

#### Data Port Connector

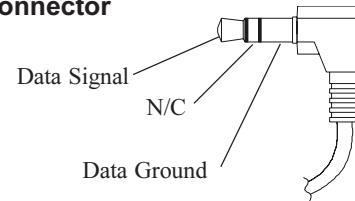

#### IR Port Connector with Rear Panel IR Power Switch Set to Off

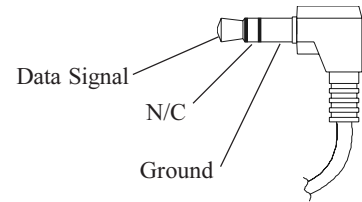

#### IR Port Connector with Rear Panel IR Power Switch Set to On

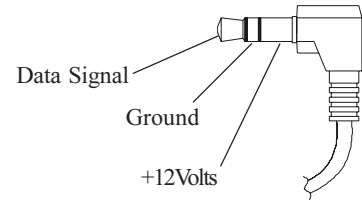

### Introduction

---

Now you can take advantage of traditional McIntosh standards of excellence in the MHT100 A/V System Controller as the heart of your Home Theater System. The MHT100 provides superior eight channel reproduction, Dolby Digital, DTS and CS-3X Back Surround Decoding combined with complete audio and video switching. The McIntosh MHT100 sets new standards for accuracy in a Home Theater System.

### Performance Features

---

- **On Screen and Multifunction Fluorescent Displays**

A comprehensive On-Screen Display capability makes it easy to perform setup adjustments using the MHT100 Remote Control. The Front Panel Display indicates volume levels, tuner functions, input selection, operating mode and setup functions.

- **Automatic Mode Switching with Auto Memory**

The MHT100 Automatically Switches Operating Modes according to the input signal. Zone A will memorize the Preferred Mode settings last used for each input. When switching from one input to another, the selected mode for each will be active.

- **Separate Listen and Record Input Selection**

The 7 Analog A/V and 6 Digital Audio Inputs can be re-assigned for any desired signal sources. All six digital inputs can be assigned to any A/V signal source. Separate Record and Listen Circuits allow recording of one program source while listening to another.

- **LED Indicators**

The MHT100 includes twenty-nine LEDs on the Front Panel to indicate what type of Operating/Decoding Modes, Power Guard, Surround Mode, Zone Selection, Late Night Dynamic Processing and the Trim Adjustment.

- **Adjustable Channel Level and Time Delay**

A built-in test signal generator allows seven channels to be calibrated for precise volume levels with either automatic or manual channel switching. The Time Delay can be adjusted to compensate for different Loudspeaker Distances to the Listening/Viewing Area.

- **Digitally Controlled Volume and Tone Controls**

A Precision Tracking Volume Control adjusts all eight channels with tracking accuracy better than 0.5dB. Digital Sound Processing allows a wide range of tone shaping with the Bass and Treble Controls with no loss in traditional McIntosh sonic excellence.

- **Video Switching**

There is also video switching for all three types of video signals, Composite Video, S-Video and Component Video.

- **External Eight Channel Input**

An external eight channel signal processor can be connected to these inputs as well as a DVD-Audio Player with a built-in processor.

- **CS-3X® Expanded Signal Processing**

The Back Surround Mode with CS-3X Signal Processing will provide the best possible reproduction of a film sound track that was originally created for use in a movie theater.

- **Dual Zone**

The MHT100 has the built-in ability to control a separate remote Audio/Video Zone with its own speakers. Zone B program selection is independent of the Zone A selected program.

### Dimensions

The following dimensions can assist in determining the best location for your MHT100. There is additional information on the next page pertaining to installing the MHT100 into cabinets.

**Front View of the MHT100**



**Rear View of the MHT100**

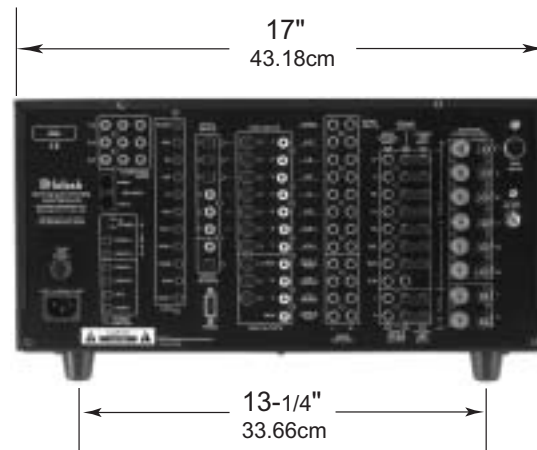

**Side View of the MHT100**

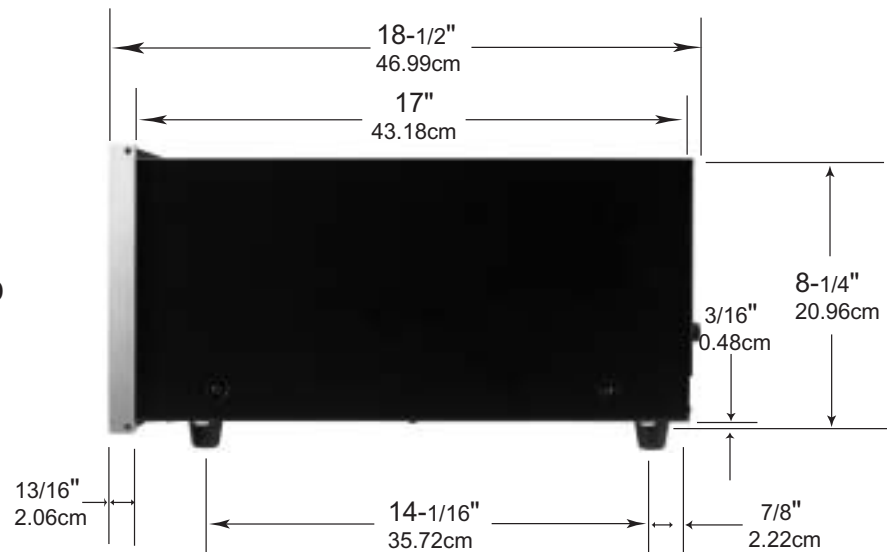



## Installation

The MHT100 can be placed upright on a table or shelf, standing on its four feet. It also can be custom installed in a piece of furniture or cabinet of your choice. The four feet may be removed from the bottom of the MHT100 when it is custom installed as outlined below. The four feet together with the mounting screws should be retained for possible future use if the MHT100 is removed from the custom installation and used free standing. The required panel cutout, ventilation cutout and unit dimensions are shown.

Always provide adequate ventilation for your MHT100. Cool operation ensures the longest possible operating life for any electronic instrument. Do not install the MHT100 directly above a heat generating component such as a high powered amplifier. If all the components are installed in a single cabinet, a quiet running ventilation fan can be a definite asset in maintaining all the system components at the coolest possible operating temperature.

A custom cabinet installation should provide the following minimum spacing dimensions for cool operation. Allow at least 4 inches (10.16cm) above the top, 2 inches (5.08cm) below the bottom and 1 inch (2.54cm) on each side of the A/V System Controller, so

that airflow is not obstructed. Allow 21 inches (53.34cm) depth behind the front panel. Allow 1 inch (2.54cm) in front of the mounting panel for knob clearance. Be sure to cut out a ventilation hole in the mounting shelf according to the dimensions in the drawing.

**MHT100 Front Panel Custom Cabinet Cutout**

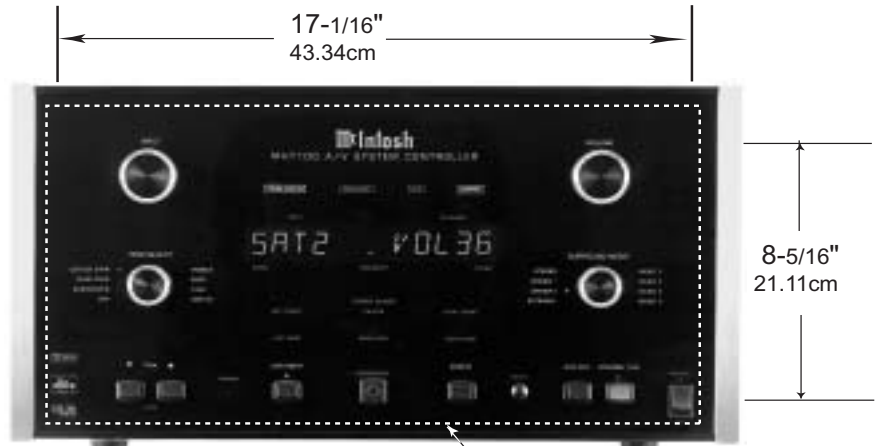

**MHT100 Side View in Custom Cabinet**

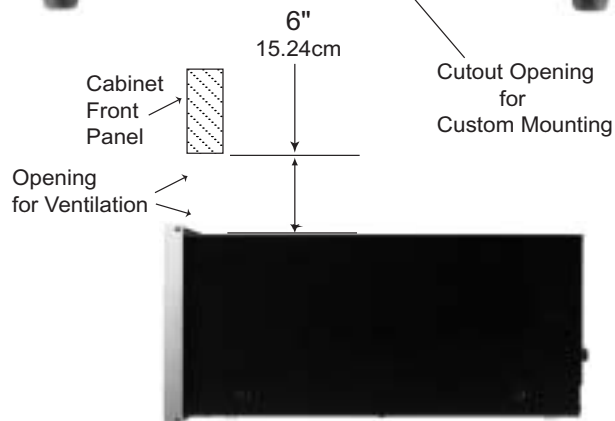

**MHT100 Bottom View in Custom Cabinet**

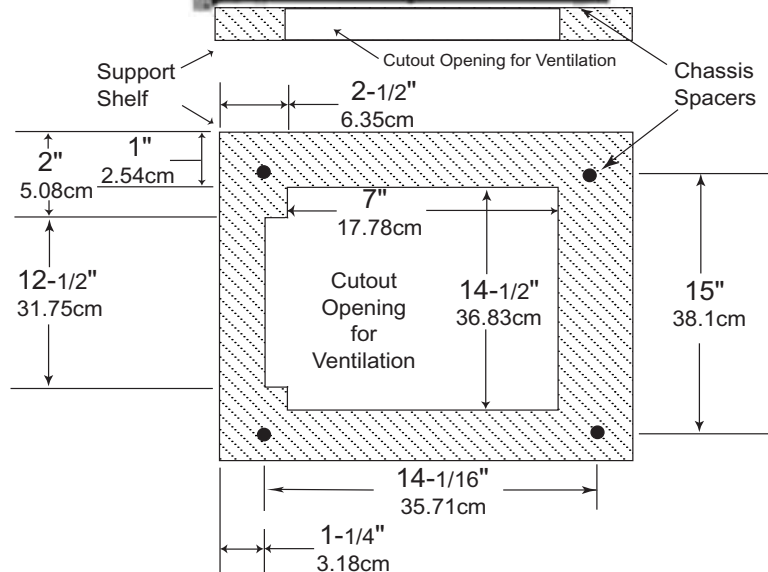

IR INPUTS for Zone A or B external Sensors. IR POWER On/Off Switch for Zone A or B external Sensors

KEYPADS ZONE A and B for a McIntosh Keypad or IR room sensor

DATA PORTS send signals to compatible source components to allow remote control operation. The SUM Data Port for Zones A and B connects to other McIntosh Components. The HOME Data Port connects to an optional Home Controller

Connections for Zone A Loudspeakers; which includes the Left, Center and Right Front Channels. There are also connections for the Left, Back and Right Surround Loudspeakers

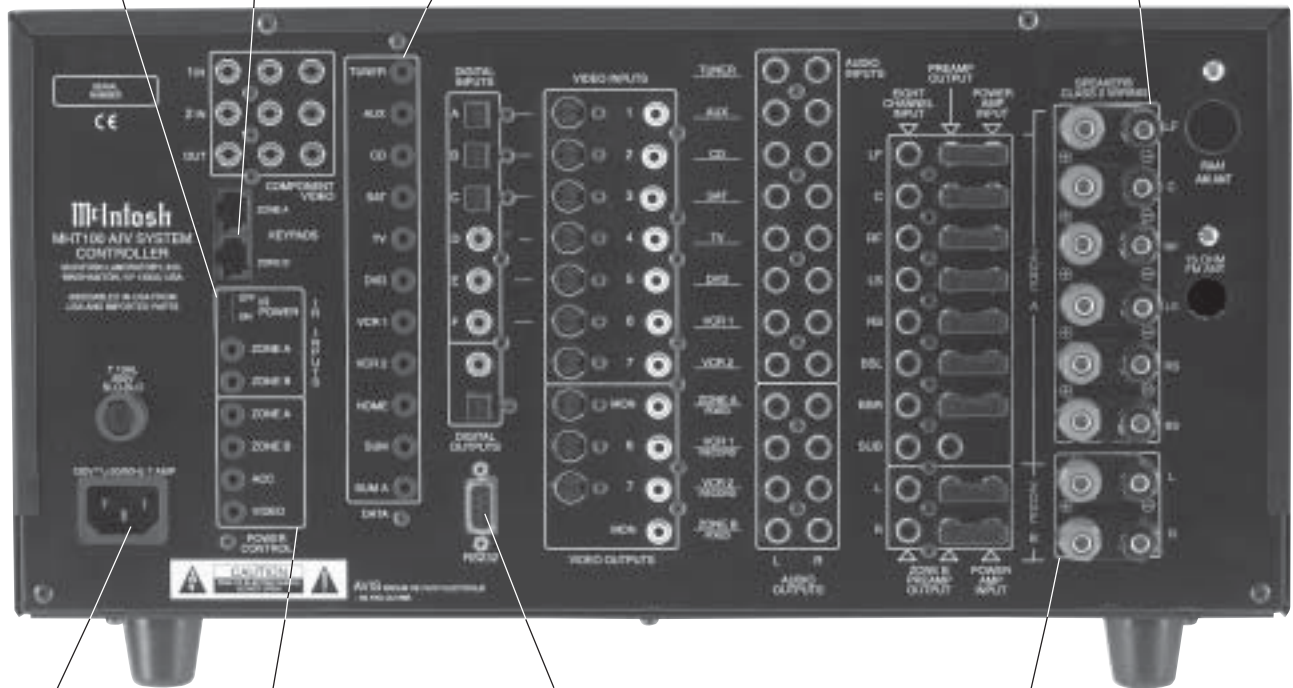

Connect the MHT100 power cord to a live AC outlet. Refer to information on the back panel to determine the correct voltage

RS232 connector for connection to a computer or other control device

POWER CONTROL A and B send a turn On/Off signal to a McIntosh Power Amplifier for both Areas. The ACC POWER CONTROL sends a turn On/Off signal to McIntosh Source Components. The VIDEO POWER CONTROL sends a turn On/Off signal to McIntosh Video Source Components

Connections for Zone B Loudspeakers, Left and Right

The Coaxial DIGITAL INPUTS AUX, CD and SAT receive a digital audio signal from the Coaxial Output of a component. The Optical DIGITAL INPUTS CD1, SAT, and LV receive a digital audio signal from the Optical Output of a component

AUDIO INPUTS for analog audio signals from a TUNER, AUX, CD, SAT, TV, DVD, VCR1 or VCR2 Components. The TUNER Left and Right jacks will provide the Tuner Audio Output Signals when the TM1 AM/FM Tuner Module is installed inside the MHT100

EIGHT CHANNEL INPUTS accept signals from a component such as DVD-Audio/SAC Players or an external processor. ZONE A PREAMP OUTPUTS provide all eight channel signals to the MHT100 Power Amplifier Inputs via the External McIntosh Plug In Jumpers. ZONE A POWER AMP INPUTS are for all eight Audio Power Amplifier Channels

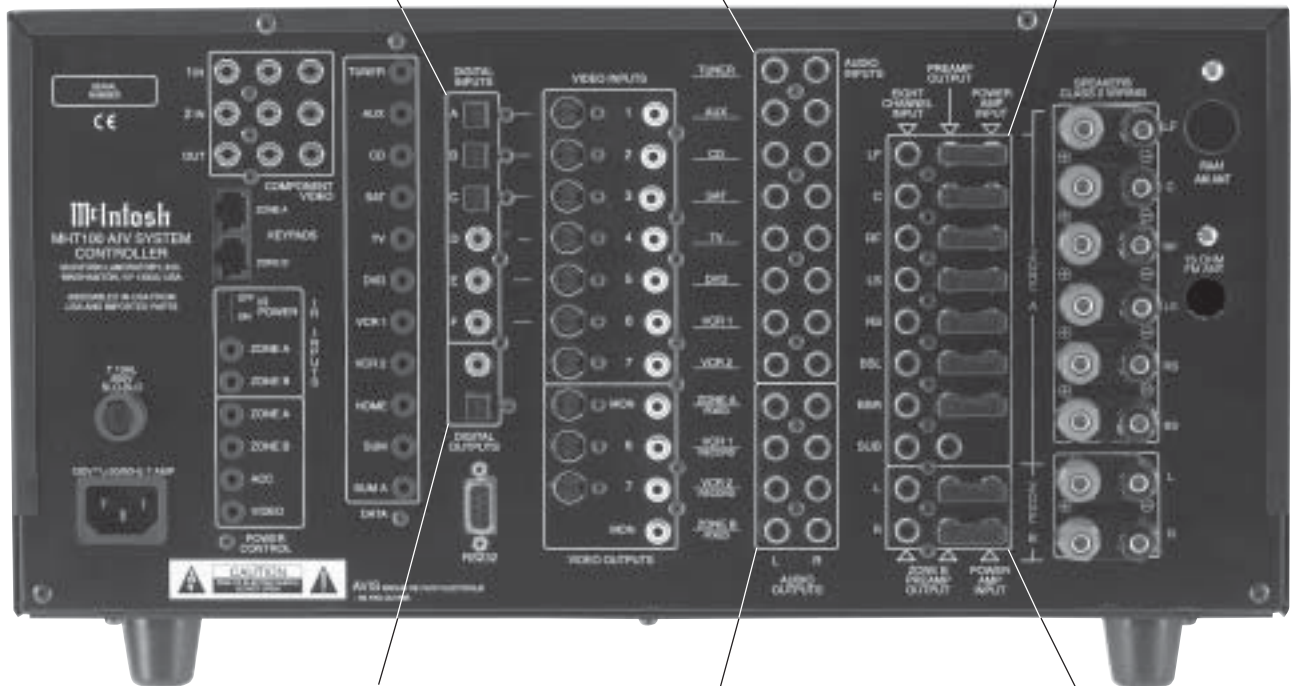

DIGITAL OUTPUTS both optical and coaxial, provide a digital audio signal to an external digital processor

ZONE B PREAMP OUTPUTS provide Left and Right Channel Audio Signals to the MHT100 Power Amplifier Inputs via the External McIntosh Plug-In Jumpers. ZONE B POWER AMP INPUTS are for both Audio Power Amplifier Channels

ZONE A FIXED OUTPUTS send a fixed line level, two channel analog signal as selected by the INPUT (Zone A Control). The OUTPUTS VCR 1 and 2 supply analog audio record signals for recorders. The ZONE B OUTPUTS send a two channel signal from the analog inputs as selected by the INPUT B Control

VIDEO INPUTS are for both S-Video and Composite Video Signals from a AUX, CD, SAT, TV, DVD, VCR1 or VCR2 components

COMPONENT INPUTS receive Component Video (Y, P<sub>R</sub> and P<sub>B</sub>) Signals from two Component Video Sources

*Note: If the MHT100 A/V System Controller has the TM1 AM/FM Tuner Module installed, proceed to page 52 for Rear Panel Antenna Connection Information.*

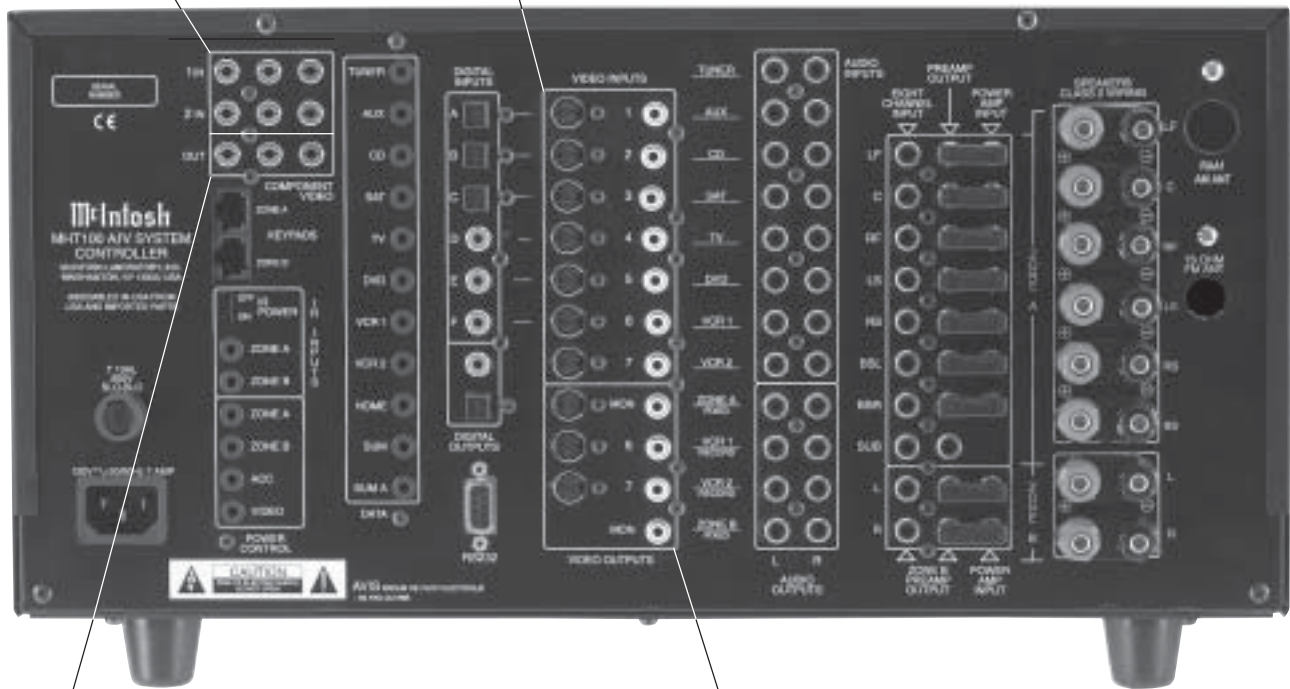

COMPONENT OUTPUTS send Component Video (Y, P<sub>R</sub> and P<sub>B</sub>) Signals to the ZONE A Video Monitor

VIDEO OUTPUTS are for supply S-Video and Composite Video Signals for recorders VCR 1 and 2. There are also MONitor Zone A S-Video and Composite Video Signal Outputs for a monitor/TV located in Zone A. The MONitor Zone B has a Composite Video Signal Output for monitor/TV located in Zone B

**How to Connect for Data and Power Control**

1. Connect a Data Control Cable from the MHT100 DVD Data Port to the McIntosh MVP841 DVD Player Data In Jack.
- Note: By adding a McIntosh Remote Control Translator to the MHT100, non McIntosh Source Devices such as a Satellite Receiver can be remotely controlled using a McIntosh Remote Control and Keypads.*
2. Connect a Data Control Cable from the MHT100 Home Data Port to the Home Controller Data In Jack.
3. Connect a 4 conductor shielded cable from the MHT100 Zone A Keypad Socket to a McIntosh WK-4 Keypad.
4. Connect a Power Control Cable from the MHT100 POWER CONTROL ACC Jack to the McIntosh MVP841 DVD Player Power Control In Jack.
5. Connect a Power Control Cable from the McIntosh MVP841 DVD Player Power Control Out Jack to the McIntosh PC-4 Power Control AC Outlet Strip Power Control Jack.
6. Connect a Power Control Cable from the MHT100 POWER CONTROL ZONE A jack to the McIntosh

- Powered Subwoofer Power Control In Jack.
7. Optionally, connect a Data Control Cable from the MHT100 IR INPUTS A to an external IR Sensor.

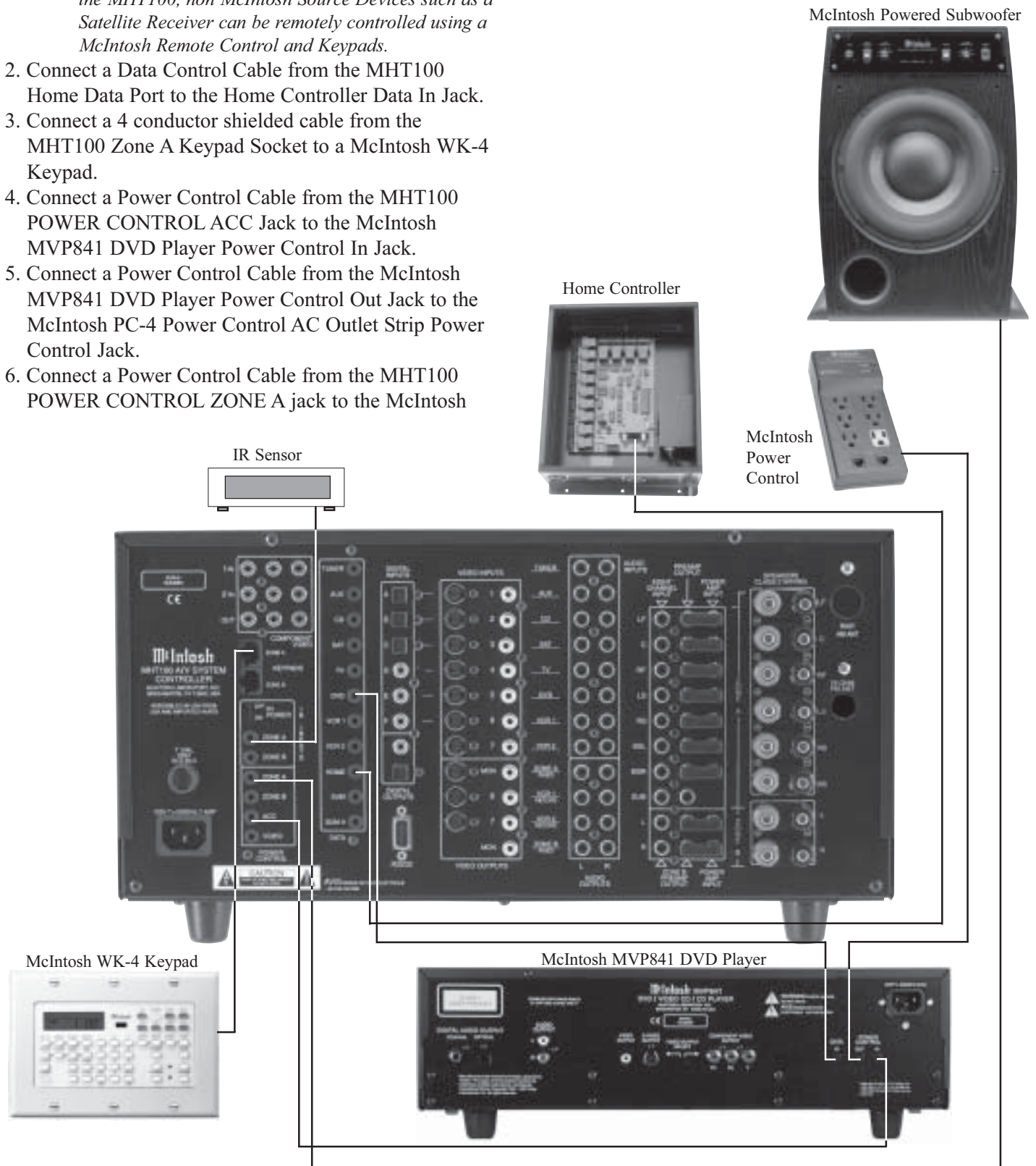

## How to Connect the Loudspeakers

**Caution:** *The supplied AC Power Cord should not be connected to the Rear Panel of the MHT100 Amplifier until after the Loudspeaker, Audio and Video Connections have been made. Failure to observe this could result in Electric Shock.*

1. Prepare the Loudspeaker Hookup Cables that attach to the MHT100 A/V System Controller by choosing one of the methods below:

### Bare wire cable ends:

Carefully remove sufficient insulation from the cable ends, refer to figures 1, 2 & 3. If the cable is stranded, carefully twist the strands together as tightly as possible.

*Note: If desired, the twisted ends can be tinned with solder to keep the strands together, or attach spade lug and/or banana connector.*

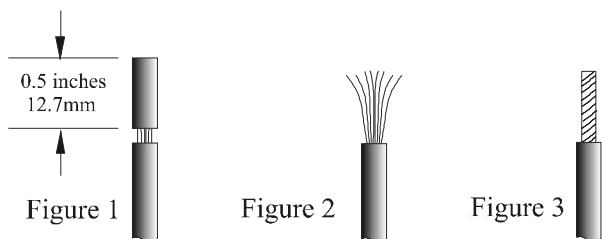

### Spade lug or prepared wire connection:

Insert the spade lug connector or prepared section of the cable end into the terminal side access hole, and tighten the terminal cap until the cable is firmly clamped into the terminal so the wires cannot slip out and there is no touching of the bare wire or spade lugs between adjacent terminals. Refer to figures 4, 5 & 6.

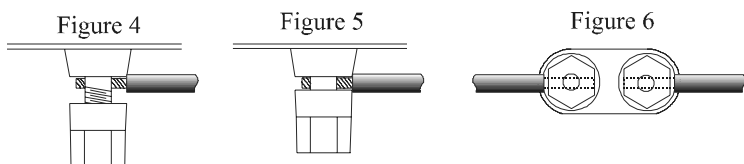

**Caution:** *Make sure there is **NO CONTACT** of either the Loudspeaker Wires or Wire Connectors between the adjacent Positive and Negative Terminal Binding Posts for each channel; and between the Terminal Binding Posts of adjacent channels.*

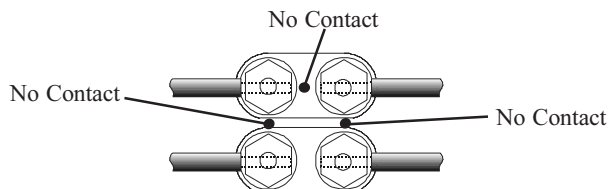

### Banana plug connection:

Insert the banana plug into the hole at the top of the terminal. Tighten the top portion of the terminal post and the set screw to secure the banana plug in place.

*Note: The use of Banana Plugs is for use in the United States and Canada only.*

2. Connect the Loudspeaker Hookup Cables from the MHT100 SPEAKERS Terminals to the Loudspeakers, being careful to observe the correct polarities and channel designation.

**WARNING:** *Loudspeaker terminals are hazardous live and present a risk of electric shock. For additional instruction on making Loudspeaker Connections contact your McIntosh Dealer or McIntosh Technical Support.*

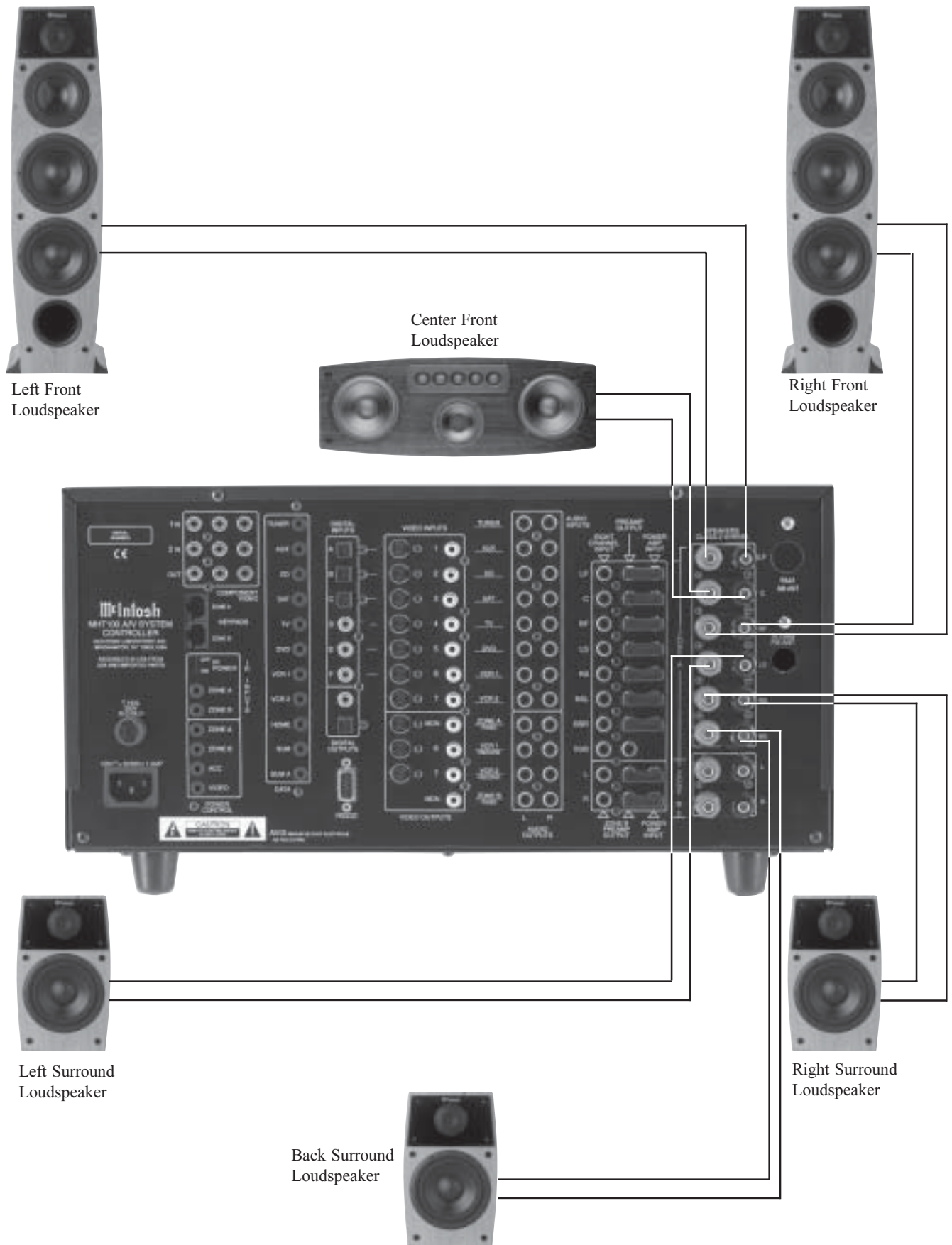

### How to Connect Audio and Digital Components

The MHT100 accepts Analog Audio and Digital Audio Signal Inputs. It is important to connect the Analog Outputs along with the Digital Audio Signal Output from source components connected to the MHT100. This will assure that the audio from that source component is available to the VCR1 and 2 Outputs and Zone B.

*Note: If MHT100 does not have the Tuner Module installed an external Tuner may be connected.*

1. Connect a cable from the MHT100 DIGITAL Coaxial DVD INPUT (Input E/5) to the McIntosh Coaxial Digital Output of the MVP841 DVD Player.
2. Connect a cable from the MHT100 AUDIO INPUTS DVD to the McIntosh Audio Outputs of the MVP841 DVD Player.
3. Connect a cable from the MHT100 SAT Optical DIGI-

TAL INPUT (Input C) to the Optical Digital output of a Satellite Receiver.

4. Connect a cable from the MHT100 Audio SAT INPUTS to the Audio Outputs of the Satellite Receiver.
5. Connect a cable from the MHT100 VCR1 Audio OUTPUT to the VCR Audio Input.
6. Connect a cable from the MHT100 VCR1 Audio INPUT to the VCR Audio Output.
7. Connect a cable from the MHT100 CD INPUT Optical DIGITAL INPUT (Input B) to the Optical Digital Output of the DVD-Audio/SAC Disk Player.
8. Connect cables from the MHT100 EIGHT CHANNEL Audio INPUTS to the DVD-Audio/SAC Disk Player Audio Outputs.
9. Connect a cable from the MHT100 ZONE A SUBwoofer PREAMP OUTPUT to the McIntosh Powered Subwoofer Line In jack.

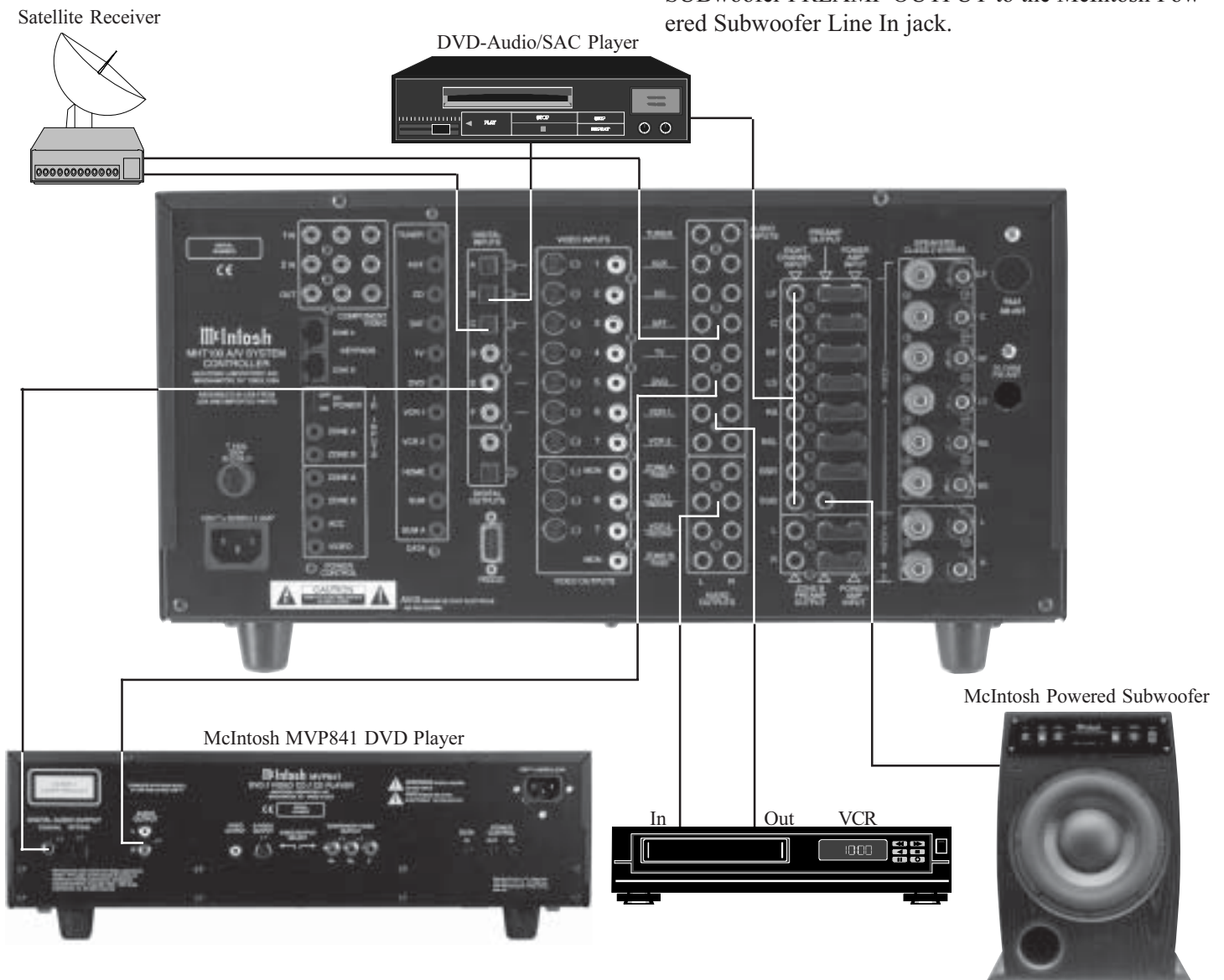



How to Connect Video Components

Composite, S-Video and Component Video Signals can be connected to and selected by the MHT100. The built-in On Screen Operating Status and Setup Information is available at the Composite and S-Video Monitor Outputs for Zone A. Connect all of the available Source Video Outputs (Component, S-Video and Composite) to the MHT100.

1. Connect video cables from the MHT100 DVD VIDEO INPUTS to the McIntosh Video Outputs of the MVP841 DVD Player.
2. Connect video cables from the MHT100 COMPONENT VIDEO 2 INputs to the McIntosh Video Outputs of the MVP841 DVD Player.  
*Note: If a DVD is to be viewed in Zone B, make sure that the Video Output Select Switch on the rear panel of the MVP841 is set to the Composite/S-Video position.*
3. Connect video cables from the MHT100 SAT VIDEO INPUTS to the Video Outputs of a Satellite Receiver.
4. Connect video cables from the MHT100 COMPONENT VIDEO 1 INputs to the Video Outputs of a Satellite Receiver.

5. Connect video cables from the MHT100 VCR1 INPUTS to the VCR Video Outputs.
6. Connect video cables from the MHT100 VCR1 OUTPUTS to the VCR Video Inputs.
7. Connect video cables from the MHT100 CD1 INPUT to the Video Outputs of the DVD-Audio/SAC Disk Player.
8. Connect video cables from the MHT100 COMPONENT Video, S-Video and Composite Video OUTPUTS to the Monitor/TV Component Video Inputs.  
*Note: If the Monitor/TV does not have Component Video Inputs, then connect the MHT100 MON A S-Video or Composite Output(s) instead.*
9. Connect the MHT100 to a live AC Outlet.  
*Note: If the Zone B is to be connected, proceed to the next page and DO NOT connect the MHT100 to a live AC Outlet at this time.*

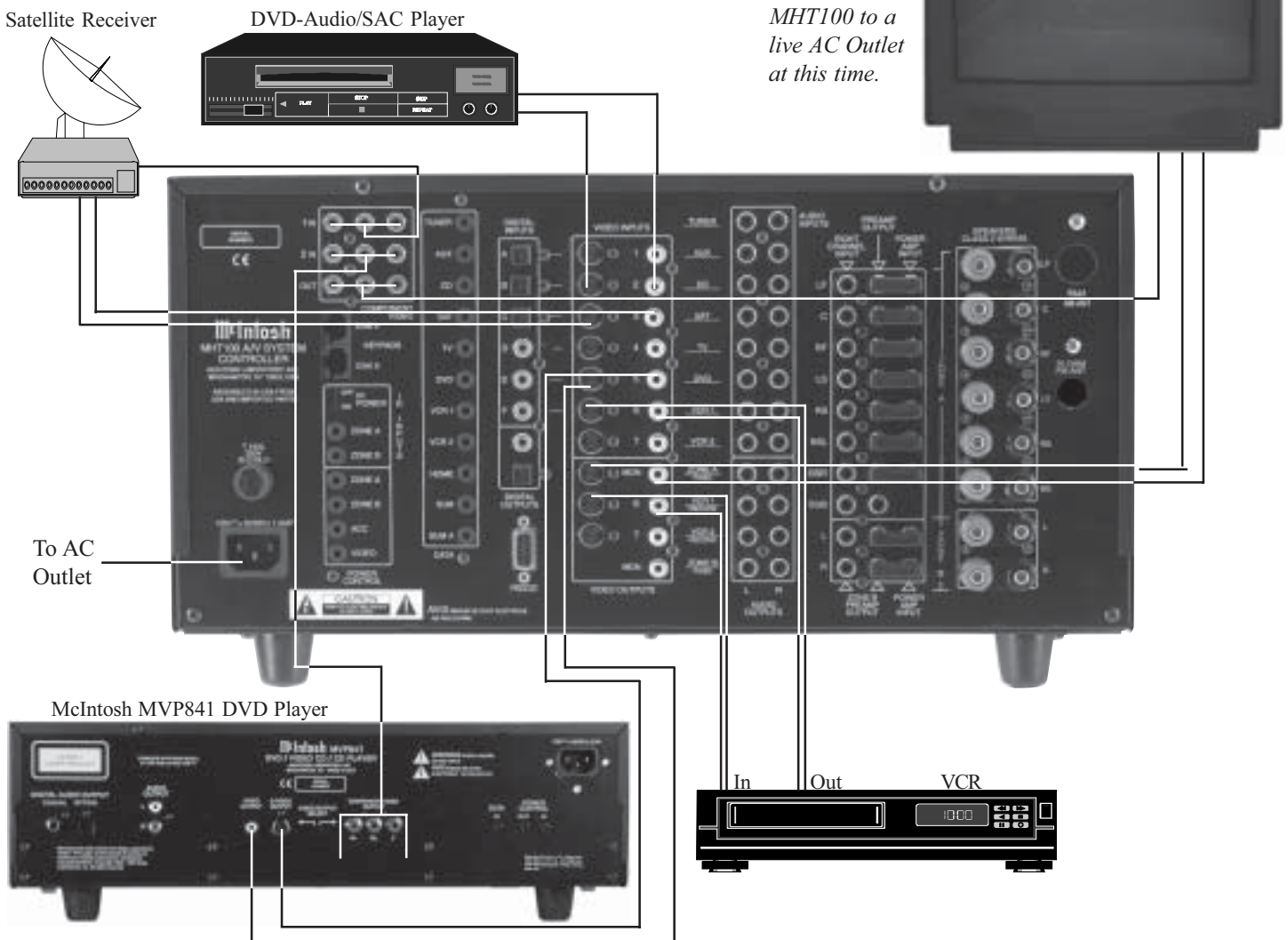

### How to Connect for Zone B

The MHT100 is a Dual Zone A/V System Controller. For Zone B activation a McIntosh Sensor or Keypad together with a pair of Loudspeakers are required. To provide the best video quality for Zone B, it is important to use a high quality cable and keep the cable length as short as possible.

1. Connect a cable from the MHT100 KEYPADS ZONE B to the McIntosh Keypad.
2. Connect a cable from the MHT100 MON ZONE B Jack to the Monitor/TV Video Input.
3. Connect the Loudspeaker Hookup Cables from the MHT100 SPEAKERS Terminals to the Loudspeakers, being careful to observe the correct polarities and channel designation. Refer to page 14 for information on repairing Loudspeaker Hookup Cables.

**WARNING: Loudspeaker terminals are hazardous live and present a risk of electric shock. For additional instruction on making Loudspeaker Connections contact your McIntosh Dealer or McIntosh Technical Support.**

4. Connect the MHT100 to a live AC Outlet.

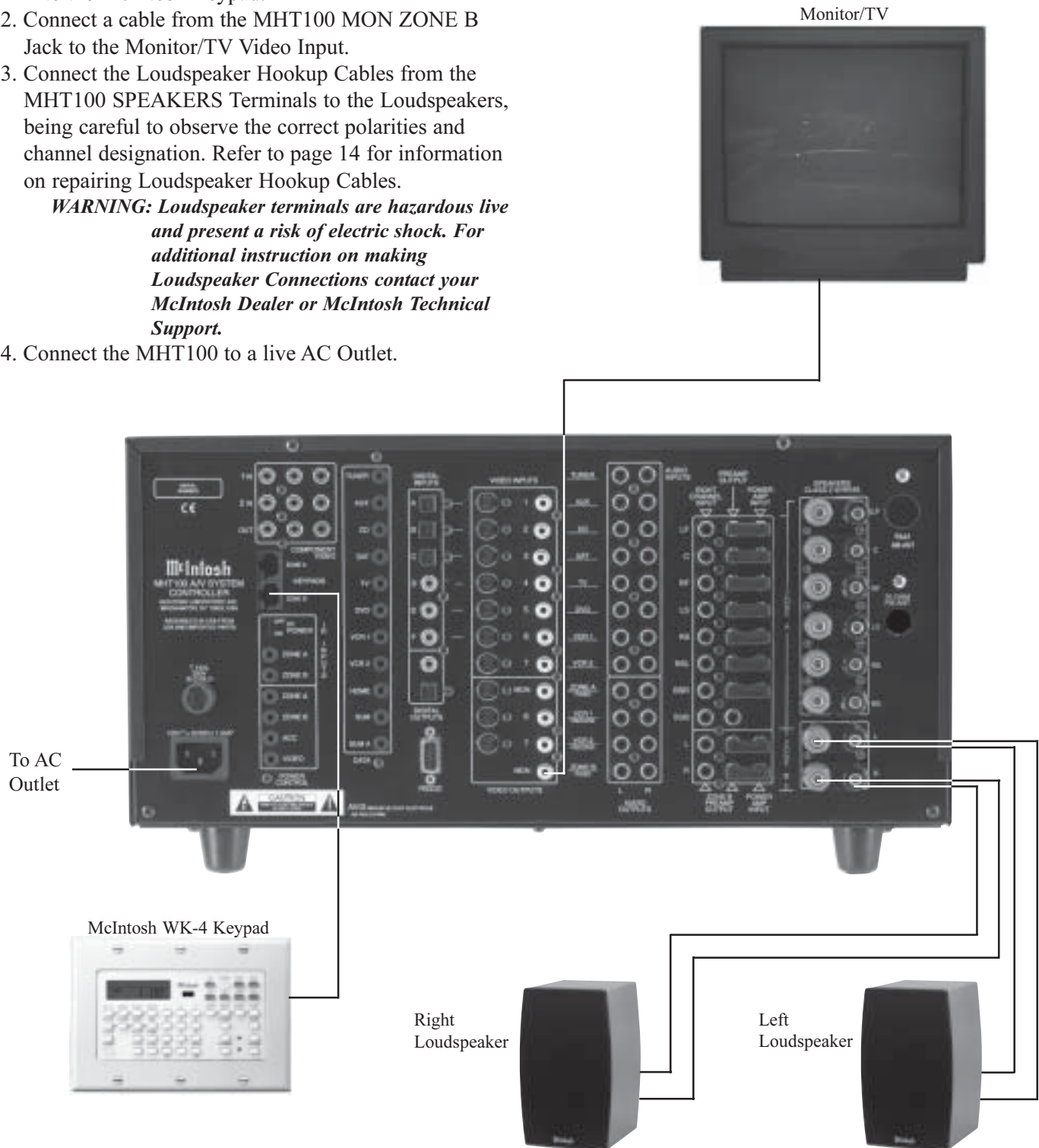

## Front Panel Controls, Sensor and Headphone Jack

Selects which of the seven Audio/Video Sources or Tuner Signal is available at the Zone A and B Audio Outputs, Component Video for Zone A, MON ZONE A and MON ZONE B Video Outputs, and available for VCR Outputs

IR (Infra Red) Sensor accepts IR signals directly from the MHT100 Remote Control

Adjusts the Listen volume level of all eight channels for Zone A and both channels for Zone B



Selects the Trim Function for making audio and front panel display adjustments

Low Impedance Dynamic Headphones can be connected for two channel listening and the Zone A Loudspeakers are automatically muted when the headphone plug is inserted

Selects the desired audio operating mode and selects the external eight channel input

Tunes Up or Down the AM or FM Broadcast Band or Presets when the TM1 Tuner Module is installed and allows up or down adjustment for each trim function

Switches Zone A On/Off and Zone B On/Off only if Zone A is already On

Activates control of Zone B, both Input Selection And Volume Adjustment



Activates the volume compression circuit, supported by selected Dolby Digital sound tracks

Press to go into Setup Mode to change the default settings

Switches all AC Power On or Off

Switches Off the entire system, both Zones A and B

Indicates which Trim Parameter has been selected

Indicates Input Selection Status, Volume, Trim Adjustments, Surround Modes, Setup Functions. The Tuner Functions are displayed when the TM1 Tuner Module is installed

Indicates the name or type of the Operating/Decoding Modes that are in use

Indicates which Channel Surround Mode is in use



Indicates when the Late Night Processing has been selected

Indicates when Zone B Control is active

Indicates when the Input Source selected is processing a Digital Signal

Indicates when the Power Guard Circuit has been activated for the Left Front, Center, Right Front, Left Surround, Right Surround or Back Surround Channels

Indicates when the MHT100 is in Standby/On Mode



### How to Operate by Remote Control

The supplied remote control is capable of directly controlling the functions of contemporary McIntosh Source Components connected to the MHT100. Earlier McIntosh Source Components and other brand source components can be controlled by the MHT100 with the addition of a McIntosh Remote Control Translator (RCT) and/or optional UR12 Touch Screen Remote Control.

*Note: Your McIntosh Dealer can assist you with the installation and operation of the Remote Control Translator (RCT).*

#### Mute

Press the MUTE Push-button to mute audio in the Zone where the command is issued. The VCR OUTPUTS are not affected by the MUTE function. The MHT100 Front Panel Alphanumeric Display will indicate the word Mute. Press MUTE a second time to unmute audio.

#### Mode

Press the MODE Push-button to select the Surround Mode from Stereo to Cinema 2 plus External Mode for listening to an Eight Channel Analog Audio Source.

#### Trim

Press the TRIM Push-button, followed by the LEVEL Up▲ or Down▼ Push-button to select various sound adjustments and MHT100 Setup Settings.

#### Input Source Selection

Press any of the eight input Push-buttons to select a program source, both audio and video.

#### CD/Tape Functions

Use these Push-buttons to operate a CD player, CD changer or tape recorder.

#### Numbered Push-buttons

Press Push-buttons 0 through 9 to access tuner station presets or CD tracks/discs.

#### Disc and Track

Use the DISC and TRACK Push-buttons when a CD player or changer is being used.

#### Tuner Push-buttons

Press the AM or FM Push-button to select the desired broadcast band. Press and release the Channel Up▲ or Down▼ Push-button to move from station to station. Press and hold a Channel Up▲ or Down▼ Push-button to skip over stations until the push-button is released. Press REVIEW to start the automatic brief audition of each of the

presets stored in the tuner memory. Press REVIEW a second time to stop on a station preset and exit the Review process.

*Note: The above Tuner Function requires either the TMI Tuner Module installed in the MHT100 or an external McIntosh Tuner connected to the MHT100.*

#### Volume

Press the Up or Down VOLUME Push-button to raise or lower the listening volume level.

*Note: The VCR OUPUTS are not affected by volume changes.*

#### Acc On

Press ACC ON to turn the power ON to a McIntosh Disc Player.

#### Acc Off

Press ACC OFF to turn the power OFF to a McIntosh Disc Player.

#### E

Press E to perform various functions on a variety of McIntosh Components. It will also pause the playing of a disc or tape player.

#### Lighting

Press and release the LIGHTING Push-button to momentarily illuminate the upper half of the remote control Push-buttons.

*Note: While the LIGHTING Push-button is being depressed, the remote control will be unable to send a remote command. When the LIGHTING Push-button is released the Push-buttons will continue to stay illuminated for approximately three seconds thus allowing you to send the desired command. If any of the translucent Push-buttons are depressed, they will continue to stay illuminated for approximately three seconds.*

#### Optional Remote Control

The McIntosh UR12 Touch Screen Remote Control combines a Multi-Page LCD Touchscreen, joystick navigation and easy to use command macros for operating all the components in your system. See your McIntosh Dealer for additional information.



## How to Operate the Setup Mode

Your McIntosh MHT100 has been factory configured for default operating settings that will allow immediate enjoyment of superb video and high fidelity audio without the need for further adjustments.

If you wish to make changes to the factory default settings (refer to the adjacent page), a System Setup Feature is provided to customize the operating settings using On Screen Menus.

### Notes:

1. To use the On-Screen Setup Menu feature, the MHT100 MON ZONE A Video Outputs (S-Video or Composite) must be connected to the video input of a Monitor/TV.
  2. There is no On-Screen Information present at the MHT100 Component Video Output.
  3. Any adjustments made to the SPEAKER settings must be performed in the correct sequence, since they are interactive.
  4. Follow the sequence listed in the MAIN SYSTEM SETUP MENU for these adjustments.
1. Press the POWER switch to ON, the Red LED above the STANDBY/ON Push-button lights to indicate the MHT100 is in Standby mode. To Turn On the MHT100 press the STANDBY/ON Push-button. The title

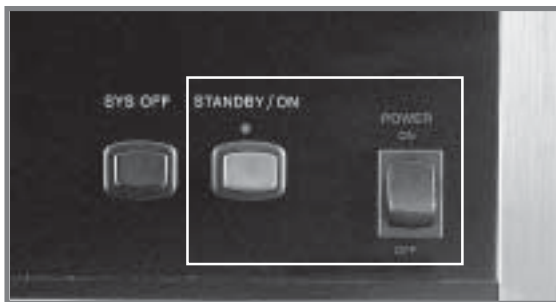

Figure 7



Figure 8

MHT100 will appear on the Front Panel Alphanumeric Display for approximately two seconds after Turn-On, with the Loudspeakers muted. Refer to figures 7, 8 & 9.

*Note: For normal operation, turn the MHT100 On and Off with the Standby/On Push-button. You may also Switch On the MHT100 by simply pressing the Power Push-button on the Remote Control. If the A/V System Controller is not going to be used for an extended period of time, turn Off all AC Power with the Power Switch.*

2. Press and hold the MHT100 Front Panel SETUP Push-button approximately three seconds to enter the Setup Mode. The word SETUP will appear on the Front Panel Alphanumeric Display and the MAIN SYSTEM SETUP Menu will appear on the Monitor/TV Screen. Refer to figures 10, 11 & 12.

3. Access the desired Setup Menu by pressing the Up▲ or Down▼ directional push-buttons followed by the SELECT Push-button on the supplied Remote Control. The desired Setup Menu will then appear on the Monitor/TV Screen. Use the Up▲ or Down▼ directional push-buttons to select the menu item and press the Left◀ or Right▶ directional push-buttons to change the current setting. Refer to figure 9.

*Note: The LEVEL Up▲ and Down▼ Push-buttons are used for Speaker Level Adjustments.*

4. After all adjustments are complete, select EXIT by pressing the Up▲ or Down▼ directional push-buttons on the remote control. Return to the MAIN SYSTEM



Figure 9

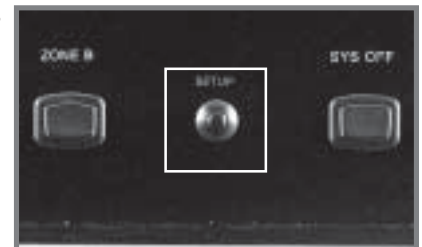

Figure 10



Figure 11





Figure 12

- SETUP Menu by pressing the SELECT Push-button.
5. Exit the MAIN SYSTEM SETUP Menu by pressing the Up▲ or Down▼ directional push-buttons followed by the SELECT Push-button.
  6. If adjustments have been performed, the Adjustment Acceptance Menu will appear on the Monitor/ TV screen asking if you want to save the adjustments in memory. Use the Up▲ or Down▼ directional push-buttons to select YES to save, or NO to not save, then press the SELECT Push-button to exit the Setup Mode and return to normal operation. Refer to figure 13.



Figure 13

**Default Settings**

The following listings indicate the factory default settings. Refer to the listed page number for instructions on how to change a default setting.

**Speaker Size:**

Speaker Type	Size or ON/OFF	Refer to Page
Front .....	Small .....	27
Center .....	Small .....	27
Surround .....	Small .....	27
Back .....	Yes .....	27
Subwoofer .....	Yes .....	27

**Speaker Time Delay:**

Speaker Location	Delay	Refer to Page
Center .....	0mS .....	28
Right Surround .....	0mS .....	28
Left Surround .....	0mS .....	28

**Speaker Level:**

Speaker Location	Initial Level	Refer to Page
Left Front .....	0dB .....	29
Center .....	0dB .....	29
Right Front .....	0dB .....	29
Right Surround .....	0dB .....	29
Back Surround .....	0dB .....	29
Left Surround .....	0dB .....	29
Subwoofer .....	0dB .....	29

**Subwoofer Settings:**

Setting	Initial Setting	Refer to Page
MC Bass .....	OFF .....	31
Sub Crossover .....	80Hz .....	31
DD LFE <sup>1</sup> Level .....	0dB .....	31

**Analog Inputs (Zones A and B):**

Number	Name	Refer to Page
1 .....	AUX .....	33
2 .....	CD .....	33
3 .....	SAT .....	33
4 .....	TV .....	33
5 .....	DVD .....	33
6 .....	VCR 1 .....	33
7 .....	VCR 2 .....	33
8 .....	TUNER .....	33

<sup>1</sup>DD (Dobly Digital) LFE (Low Frequency Effect) Sound Information is usually assigned to the Subwoofer Channel. If the Subwoofer Channel is switched off and the Front Channel Loudspeakers are set to Large in the Speaker Size Setup Menu, the LFE Sound Information will be redirected to the Large Loudspeaker(s).

## Default Settings, con't

### Analog Input Trim (Zones A and B):

Name	Level	Refer to Page
AUX .....	0.0dB .....	34
CD .....	0.0dB .....	34
SAT .....	0.0dB .....	34
TV .....	0.0dB .....	34
DVD .....	0.0dB .....	34
VCR 1 .....	0.0dB .....	34
VCR 2 .....	0.0dB .....	34
TUNER .....	0.0dB .....	34

### Digital Inputs (Zones A):

Letter	Name	Refer to Page
A .....	AUX .....	34
B .....	CD .....	34
C .....	SAT .....	34
D .....	TV .....	34
E .....	DVD .....	34
F .....	VCR 1 .....	34

### Component Video Inputs (Zones A):

Number	Name	Refer to Page
1 .....	SAT .....	34
2 .....	DVD .....	34

### Video Power Control:

Number	Power Control	Refer to Page
1-8 .....	Power On .....	36

### Trim Select (Zones A):

Adjustment	Setting	Refer to Page
Subwoofer .....	0dB .....	43
Surr Spkr .....	0dB .....	43
Center Spkr .....	0dB .....	43
Treble .....	0dB .....	44
Bass .....	0dB .....	44
Display .....	8 .....	44

### Surround Modes (Zones A):

Name	Mode	Refer to Page
AUX .....	Stereo .....	45
CD .....	Stereo .....	45
SAT .....	Stereo .....	45
TV .....	Stereo .....	45
DVD .....	Stereo .....	45
VCR 1 .....	Stereo .....	45
VCR 2 .....	Stereo .....	45
TUNER .....	Stereo .....	45

### Tuner Presets\* (Zones A and B):

Presets	Initial Settings	Refer to Page
FM 1-9 .....	Manual Tune, 87.50MHz, no Title, not assigned .....	53
AM 1-9 .....	Manual Tune, 520.00KHz, no Title, not assigned .....	53

### System Settings (for North America):

Name	Settings	Refer to Page
Video .....	NTSC .....	38
Tuner .....	USA .....	38
Temporary Display ....	Full .....	38

*\*The Tuner Presets are applicable only if the TMI AM/FM Tuner Module is installed inside the MHT100.*

## How to Reset the MHT100

If it should become necessary to reset the MHT100 to the Default Settings, follow the procedure below:

- Notes:*
1. First, if you are experiencing difficulties in operating the MHT100, place the POWER ON/OFF in the OFF Position for 5 minutes and then place it in the ON Position. Turn-On the MHT100 using the STANDBY/ON Push-button.
  2. If the above step doesn't return the MHT100 to normal operation then call your dealer for assistance or McIntosh Technical Support.
  3. Returning the MHT100 to Default Setup Settings should be a last resort, not the first.
  4. If possible, first write down any current Setup Settings and Tuner Presets before proceeding, as all settings will be returned factory default condition.

Press the POWER switch to ON, the Red LED above the STANDBY/ON Push-button lights to indicate the MHT100 is in Standby mode. Press the STANDBY/ON Push-button, then immediately press and hold in the SETUP Push-button before the title of MHT100 appears on the Front Panel Alphanumeric Display. When the Front Panel Alphanumeric Display indicates SET DEFAULTS release the the SETUP Push-button.

*Note: The Video Format will return to North American Settings. If the MHT100 is used outside of North America and requires different settings, refer to System Settings on page 38.*

## How to Adjust for Loudspeaker Size

A Home Theater System can include a variety of Loudspeakers with various capabilities. The LARGE listing refers to the Loudspeaker capability for reproducing bass frequencies down to 35Hz within -3dB of the midrange frequencies. If a Loudspeaker can not reproduce bass frequencies down to 35Hz within -3dB of the midrange frequencies it is considered SMALL. If you do not have a Subwoofer, you must have Front (Left and Right) Loudspeakers that are LARGE in order to hear the low frequencies below the Subwoofer Crossover Setting (40-140Hz) . If you are unsure as to the bass performance capabilities of your Loudspeakers, select the SMALL setting.

1. Press and hold the Front Panel SETUP Push-button approximately three seconds to enter the Setup Mode. The word SETUP will appear on the MHT100 Front Panel Display and the MAIN SYSTEM SETUP Menu will appear on the Monitor/TV screen. Refer to figure 12 on page 25.
2. Using the Up▲ or Down▼ directional push-buttons select Speaker Size on the On-Screen Menu, followed by the SELECT Push-button on the Remote Control. Refer to figure 14.

*Note: The very first time the SPEAKER SIZE MENU is accessed, the factory default settings will be indicated.*

3. Select the appropriate Loudspeaker location and type by using the Up▲ or Down▼ directional push-buttons to select first the menu item and then press the Left◀ or Right▶ directional push-buttons to change the current setting. When all of the settings on the SPEAKER SIZE MENU agree with the Loudspeakers in your Home Theater System, select EXIT on the menu. The MAIN SYSTEM SETUP Menu will reappear on the Monitor/TV screen.
4. Continue next to the SPEAKER TIME DELAY Settings. If you do not wish to perform SPEAKER TIME DELAY adjustments at this time, proceed to the next step.
5. Select EXIT from the MAIN SYSTEM SETUP Menu. If you are satisfied with the changes that you may have made, select YES to save those changes or NO not to save them. The MHT100 will then return to normal operation. Refer to figure 15.

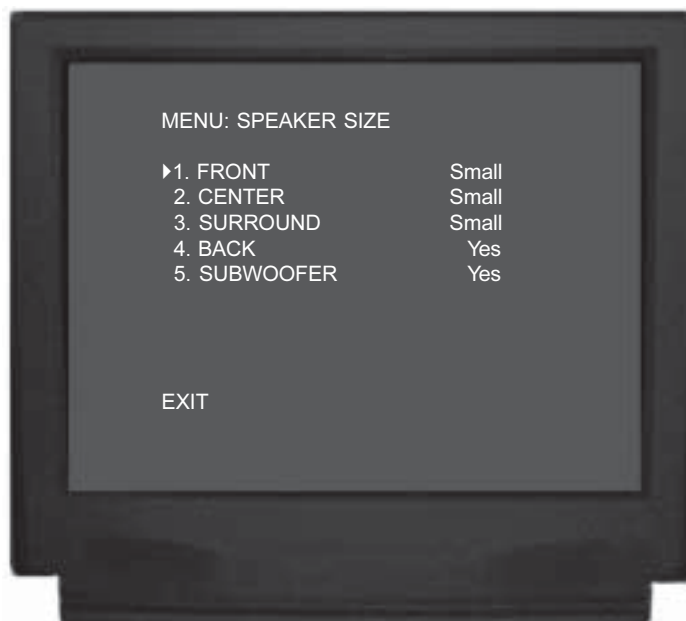

Figure 14

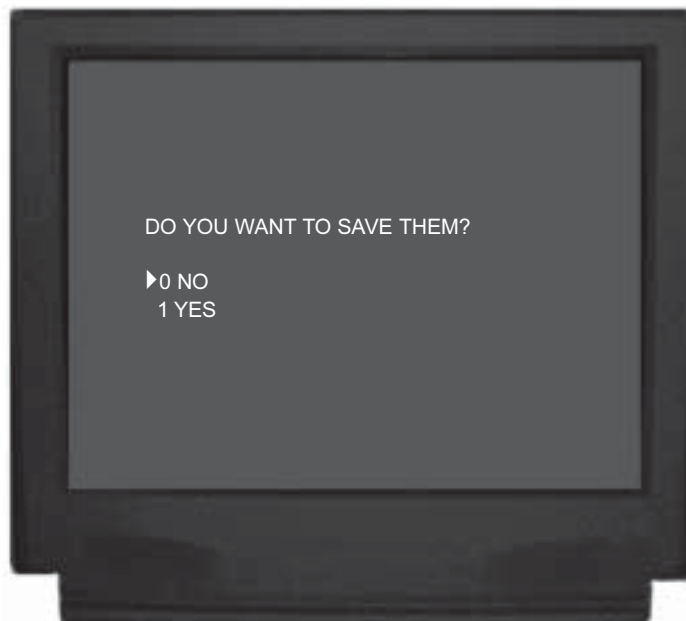

Figure 15

Loudspeaker Size		
Loudspeaker	Default Setting	New Setting
Front (L&R)	Small	
Center	Small	
Surround (L&R)	Small	
Back	Yes	
Subwoofer	Yes	

## How to Adjust Speaker Time Delay

The following Time Delay Adjustments will electronically compensate for different Loudspeaker Distances from the Listening/Viewing Area. Refer to figure 16. Time delay is measured in milliseconds(ms) and each millisecond corresponds approximately to one foot. The distance of the Front Left & Right Loudspeakers from the Listening/Viewing Area become the reference for measurements, as their signals are not delayed. The delays can be adjusted from 0 to 5ms for the

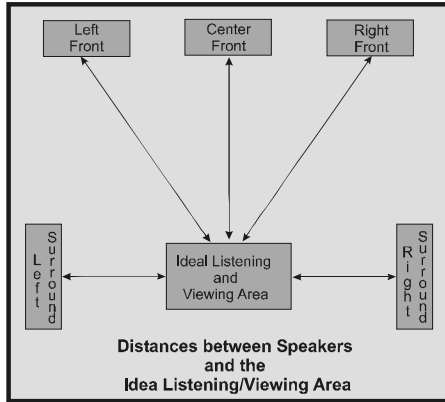

Figure 16

Center Channel Speaker and 0 to 15ms for the Left & Right Surround Channel Speakers. The Back Surround Loudspeaker Delay is internally set, based on the settings entered in for the Left and Right Surround Loudspeakers.

*Note: Before performing the TIME DELAY adjustments, complete the SPEAKER SIZE adjustments first.*

1. Press and hold the Front Panel SETUP Push-button approximately three seconds to enter the Setup Mode. The word SETUP will appear on the MHT100 Front Panel Display and the MAIN SYSTEM SETUP Menu will appear on the Monitor/TV screen. Refer to figure 12 on page 25.

2. Using the Up▲ or Down▼ directional push-buttons select Speaker Time Delay on the On-Screen Menu, followed by the SELECT Push-button on the Remote Control. Refer to figure 17.

*Note: The first time the SPEAKER TIME DELAY MENU is accessed, the default settings will be indicated.*

3. Measure the distance from the Listening/Viewing Area to each of the Loudspeakers. Refer to the table below.

*Note: A distance measurement that contains fractions of a foot, should be rounded up or down to the nearest whole number. If the Center or Surround Loudspeakers distance is less than the Left/Right Front Loudspeakers, set the delay to 0 ms.*

4. Select the appropriate Loudspeaker location and type by using the Up▲ or Down▼ directional push-buttons to select first the menu item and then press the Left◀ or Right▶ directional push-buttons to change the current setting.

*Example: If the Left and Right Front Loudspeakers are 10 feet from the*



Figure 17

*Listening/Viewing Area and the Center Channel Loudspeaker is measured at eight feet then set the Center Speaker Delay to 2ms, for the two foot difference in Loudspeaker Distance.*

*Formula: Front Left or Right Loudspeaker Distance - Center Loudspeaker Distance = Difference Distance x 1ms = new setting in milliseconds*

When all of the settings on the SPEAKER TIME DELAY MENU agree with the Loudspeakers measured distances in your Home Theater System then select EXIT on the menu. The MAIN SYSTEM SETUP Menu will reappear on the Monitor/TV screen.

5. Continue next to the SPEAKER LEVEL Settings. If you do not wish to perform SPEAKER LEVEL Adjustments at this time, proceed to the next step.
6. Select EXIT from the MAIN SYSTEM SETUP Menu. If you are satisfied with the changes that you may have made, select YES to save those changes or NO not to save them. The MHT100 will then return to normal operation. Refer to figure 13 on page 25.

Loudspeaker Time Delay				
Location	Distance	Differences	Default Setting	New Setting
Left Front		0	-	-
Center			0ms	
Right Front		0	-	-
Right Surround			0ms	
Left Surround			0ms	

## How to Adjust Speaker Levels

A properly setup Home Theater surround sound system should have all Loudspeaker levels adjusted to the same starting reference volume level in the Listening/Viewing Area. The MHT100 includes a built-in test signal generator, which can have its output switched into each Loudspeaker, either automatically or manually. The desired test signal volume levels of each Loudspeaker can be determined, in the Listening/Viewing area, either by listening or with a sound pressure meter. Level adjustments are made in small steps (1/2 dB) by using the MHT100 Remote Control LEVEL Push-button. The level can be adjusted over a plus or minus 15dB range.

*Notes: Before adjusting the SPEAKER LEVELs, you FIRST must have performed the SPEAKER SIZE and SPEAKER TIME DELAY adjustments. The SPEAKER LEVEL On-Screen Display will indicate NONE for any channel(s) that have been switched off in the SPEAKER SIZE Menu. A sound level pressure meter will greatly aid in adjusting the Loudspeaker levels.*

1. Press and hold the Front Panel SETUP Push-button approximately three seconds to enter the Setup Mode. The word SETUP will appear on the MHT100 Front Panel Display and the MAIN SYSTEM SETUP Menu will appear on the Monitor/TV screen. Refer to figure 12 on page 25.
2. Using the Up▲ or Down▼ directional Push-buttons select Speaker Level on the On-Screen Menu, followed by the SELECT Push-button on the Remote Control.  
*Note: The very first time the SPEAKER LEVEL MENU is accessed, the factory default settings will be indicated.*
3. Determine whether you wish to use the Automatic or Manual Loudspeaker Level Switching Mode. For Automatic switching, proceed to Step 4. For manual switching proceed to Step 10 on page 30.

### Automatic Loudspeaker Level Switching

4. Using the Up▲ or Down▼ directional push-buttons select number 1 (NOISE) from the Speaker Level On-Screen Menu, followed by pressing the Left◀ or Right▶ directional push-buttons to activate the Automatic Loudspeaker Switching Mode. Refer to figure 18.

*Note: The word OFF, located to the far right of the word NOISE, will change to show which channel is active for making a level change. A G Clef Symbol (♩) will also appear to the right of the numerical value instead of dB. The test signal will start cycling continuously through all Loudspeakers in 3-second intervals.*



Figure 18

5. While in the Listening/Viewing area, note the volume levels from each of the Loudspeakers as the test signal switches. If you determine that the test signal volume is louder or softer in any of the Loudspeakers, the levels should be adjusted so you hear the same test signal volume from all of the Loudspeakers.

*Note: The Left Front Loudspeaker volume level can serve as a reference.*

6. As the test signal stops at each Loudspeaker, adjust the volume of the test signal by pressing the LEVEL Up▲ or Down▼ Push-button on the Remote Control. If an adjustment is made on a Loudspeaker, there is an additional 3-second time interval before the system switches to the next Loudspeaker. As a level is changed, the on-screen display instantly indicates the level change.

*Note: If the level is increased or decreased, the display will indicate numbers or minus numbers.*

7. As the test signal switches to succeeding Loudspeakers, repeat the level adjustment process until the test signal volume levels of all the Loudspeakers are the same, then select EXIT on the menu. The MAIN SYSTEM SETUP Menu will reappear on the Monitor/TV screen.

*Note: The Loudspeaker level cycling mode can be repeated as often as necessary.*

8. Continue next to the SUBWOOFER SETTINGS. If you do not wish to perform SUBWOOFER SETTINGS Adjustments at this time, then proceed to the next step.

## How to Adjust Speaker Levels, con't

9. Select EXIT from the MAIN SYSTEM SETUP Menu.  
If you are satisfied with the changes that you may have made, select YES to save those changes or NO not to save them. The MHT100 will then return to normal operation. Refer to figure 13 on page 25.

### Manual Speaker Level Switching

The Manual Speaker Level Switching Mode allows for using either the built-in Noise Source or using an external Audio Test Source for setting the Loudspeaker Levels. If you choose to use the built-in Noise Source proceed to step 10; go to step 18 for using an external Audio Test Source.

#### Using Built-in Noise Source:

10. Using the Up▲ or Down▼ directional push-buttons select number 1 (NOISE) from the Speaker Level On-Screen Menu, followed by pressing the Left◀ or Right▶ directional push-buttons to activate the Automatic Loudspeaker Switching Mode. Refer to figure 18.

*Note: The word OFF, located to the far right of the word NOISE, will switch to show which channel is active for making a level change. A G Clef Symbol (♩) will also appear to the right of the numerical value instead of dB. The test signal will start cycling continuously through all Loudspeakers in 2-second intervals.*

11. Using the Up▲ or Down▼ directional push-buttons select number 2 (LEFT FRONT) from the Speaker Level On-Screen Menu. Refer to figure 19.
12. Adjust the volume of the test signal by pressing the LEVEL Up▲ or Down▼ Push-button on the Remote Control.

*Note: The Left Front Loudspeaker volume level can serve as a reference. If the level is increased or decreased, the display will indicate numbers or minus numbers.*

13. Using the Up▲ or Down▼ directional push-buttons select number 3 (CENTER) from the Speaker Level On-Screen Menu.
14. Adjust the volume of the test signal by pressing the LEVEL Up▲ or Down▼ Push-button on the Remote Control.
15. Repeat the level adjusting procedure as often as necessary until you are satisfied that the volume levels are the same from all of the Loudspeakers, then select EXIT on the menu. The MAIN SYSTEM SETUP Menu will reappear on the Monitor/TV screen.



Figure 18



Figure 19

16. Continue next to the SUBWOOFER SETTINGS. If you do not wish to perform SUBWOOFER SETTINGS Adjustments at this time, then proceed to the next step.
17. Select EXIT from the MAIN SYSTEM SETUP Menu. If you are satisfied with the changes that you may have made, select YES to save those changes or NO not to save them. The MHT100 will then return to normal operation. Refer to figure 13 on page 25.

Using External Audio Source:

18. Using the Up▲ or Down▼ directional push-buttons select number 2 (LEFT FRONT) from the Speaker Level On-Screen Menu. Refer to figure 19.
19. Adjust the volume of the test signal by pressing the LEVEL Up▲ or Down▼ Push-button on the Remote Control.

*Note: The Left Front Loudspeaker volume level can serve as a reference. If the level is increased or decreased, the display will indicate numbers or minus numbers.*

20. Using the Up▲ or Down▼ directional push-buttons select number 3 (CENTER) from the Speaker Level On-Screen Menu.
21. Adjust the volume of the test signal by pressing the LEVEL Up▲ or Down▼ Push-button on the Remote Control.
22. Repeat the level adjusting procedure as often as necessary until you are satisfied that the volume levels are the same from all of the Loudspeakers, then select EXIT on the menu. The MAIN SYSTEM SETUP Menu will reappear on the Monitor/TV screen.
23. Continue next to the SUBWOOFER SETTINGS. If you do not wish to perform SUBWOOFER SETTINGS Adjustments at this time, proceed to the next step.
24. Select EXIT from the MAIN SYSTEM SETUP Menu. If you are satisfied with the changes that you may have made, select YES to save those changes or NO not to save them. The MHT100 will then return to normal operation. Refer to figure 13 on page 25.



Figure 20

Loudspeaker Levels		
Location	Default Setting	New Setting
Left Front	0.0dB	
Center	0.0dB	
Right Front	0.0dB	
Right Surround	0.0dB	
Back Surround	0.0dB	
Left Surround	0.0dB	
Subwoofer	0.0dB	

## How to Adjust the Subwoofer Settings

The Subwoofer Settings allow for optimizing performance in the Home Theater System that relate to Room Acoustics and Loudspeaker Characteristics. For most Home Theater Loudspeaker Systems the default setting will produce the best performance. Refer to the Owner's Manual that came with the Loudspeaker, your dealer and/or the manufacture of the Loudspeaker for recommendations.

*Note: Before adjusting the SUBWOOFER SETTINGS, you FIRST must have performed the SPEAKER SIZE, SPEAKER TIME DELAY and SPEAKER LEVEL Adjustments.*

1. Press and hold the Front Panel SETUP Push-button approximately three seconds to enter the Setup Mode. The word SETUP will appear on the MHT100 Front Panel Display and the MAIN SYSTEM SETUP Menu will appear on the Monitor/TV screen. Refer to figure 12 on page 25.
2. Using the Up▲ or Down▼ directional push-buttons select Subwoofer Settings on the On-Screen Menu, followed by the SELECT Push-button on the Remote Control.

*Note: The very first time the SUBWOOFER SETTINGS is accessed, the factory default settings will be indicated.*

### Mc Bass Mode

When a Home Theater System contains Loudspeakers that are referred to as Large, the Bass Management Circuitry will steer all the Low Frequency Sounds away from the Subwoofer and to the Large Loudspeakers. With the MC BASS MODE set to ON the Low Frequency Sounds are sent to both the Large Loudspeakers and to the Subwoofer, thus increasing the total low frequency output of the Home Theater System. The default setting for the MC BASS MODE is OFF. Refer to figure 21 and perform the following steps to switch it On.

3. Using the Up▲ or Down▼ directional push-buttons select MC BASS MODE from the On-Screen Menu, followed by pressing the Left◀ or Right▶ directional push-buttons to active the circuit. Select EXIT on the menu and the MAIN SYSTEM SETUP Menu will reappear on the Monitor/TV screen.
4. Continue to the next Subwoofer Setting, Sub Crossover. If you do not wish to perform the remaining SUBWOOFER SETTINGS Adjustments at this time, then proceed to the next step.
5. Select EXIT from the MAIN SYSTEM SETUP Menu. If you are satisfied with the changes that you may have made, select YES to save those changes or NO not to save them. The MHT100 will then return to normal op-

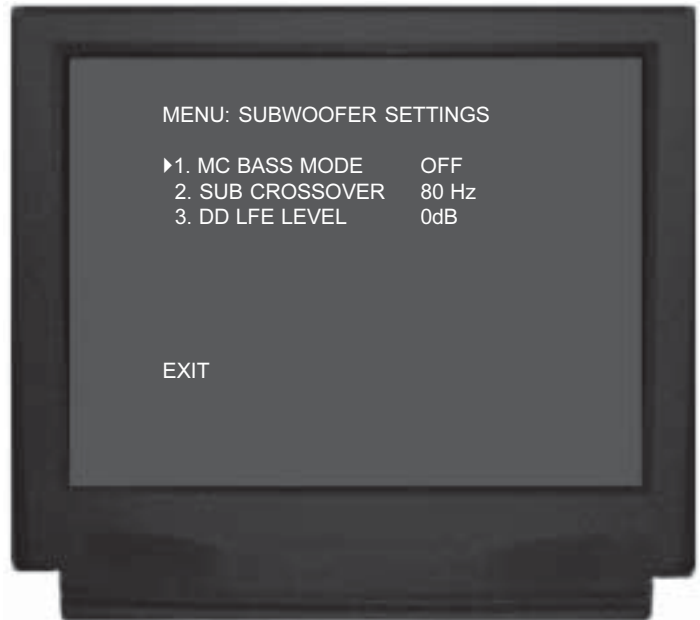

Figure 21

eration. Refer to figure 13 on page 25.

### Sub Crossover

The MHT100 incorporates a built-in Electronic Crossover. The Crossover will redirect all of the audio frequencies below the crossover frequency setting to the Subwoofer and all the frequencies above the setting to the appropriate remaining Home Theater Loudspeakers. The default setting for the SUB CROSSOVER frequency setting is 80 Hz, which is the correct frequency for most Home Theater Loudspeaker Systems. Refer to figure 22 and perform the following steps to change the setting.

6. Using the Up▲ or Down▼ directional push-buttons select SUB CROSSOVER from the On-Screen Menu, followed by pressing the Left◀ or Right▶ directional push-buttons to change the crossover frequency to the desired setting. Select EXIT on the menu and the MAIN SYSTEM SETUP Menu will reappear on the Monitor/TV screen.  
*Note: The range of adjustment is from 40Hz to 140Hz in 10Hz increments.*
7. Continue next to the DD LFE LEVEL. If you do not wish to perform DD LFE LEVEL Adjustments at this time, proceed to the next step.
8. Select EXIT from the MAIN SYSTEM SETUP Menu. If you are satisfied with the changes that you may have



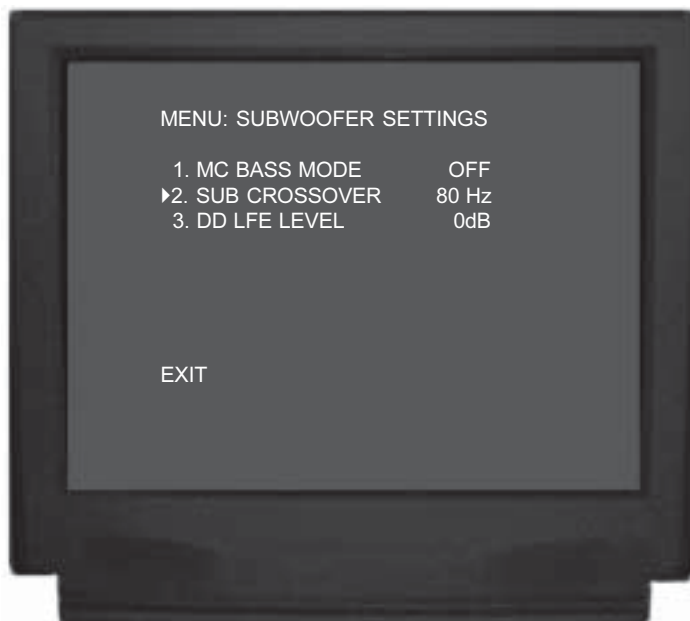

Figure 22

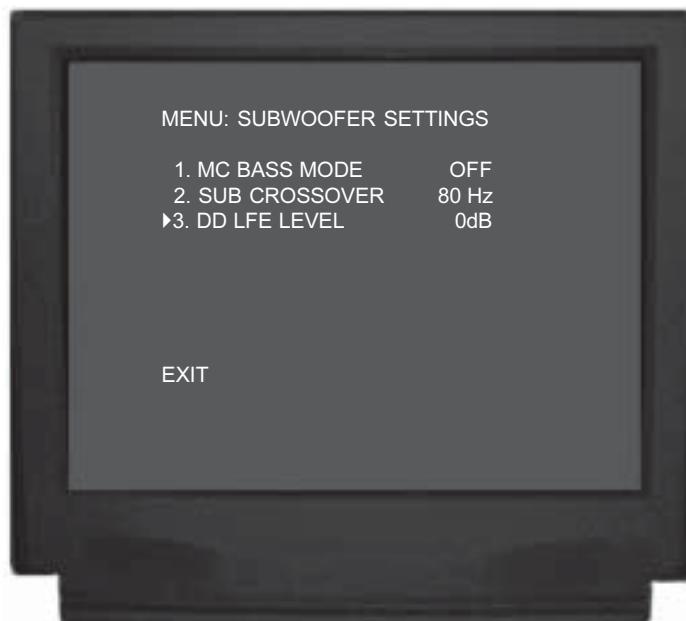

Figure 23

made, select YES to save those changes or NO not to save them. The MHT100 will then return to normal operation. Refer to figure 13 on page 25.

**DD LFE Level**

The Digital Processing Circuitry in the MHT100 allows for a reduction in the overall low frequency output level of the Home Theater System. This desired reduction may be as a result of the Loudspeakers in the systems, the average low frequency level found in the program sources, room acoustics and/or the need not to disturb person(s) that are nearby the Home Theater Listening Room. The default setting for the DD (Dolby Digital) LFE (Low Frequency Effect) LEVEL setting is 0db and is the correct setting for most Home Theater Systems. Refer to figure 23 and perform the following steps to change the setting.

*Note: If the overall low frequency output level is reduced by using the DD LFE LEVEL Adjustment and certain program source materials appear to be deficient in low frequency output, they can be increased by using the MHT100 Subwoofer Trim Level Control on the Front Panel or Remote Control.*

9. Using the Up▲ or Down▼ directional push-buttons

select DD LFE LEVEL from the On-Screen Menu, followed by pressing the Left◀ directional push-button to reduce the level. The Right▶ directional push-button increase the level back towards 0dB. Select EXIT on the menu and the MAIN SYSTEM SETUP Menu will reappear on the Monitor/TV screen.

- 10. Continue next to the SOURCE SETTINGS. If you do not wish to perform SOURCE SETTINGS Adjustments at this time, proceed to the next step.
- 11. Select EXIT from the MAIN SYSTEM SETUP Menu. If you are satisfied with the changes that you may have made, select YES to save those changes or NO not to save them. The MHT100 will then return to normal operation. Refer to figure 13 on page 25.

Subwoofer Settings		
Subwoofer Adjustment	Default Setting	New Setting
MC BASS MODE	OFF	
SUB CROSSOVER	80HZ	
DD LFE LEVEL	0dB	

## How to change Source Settings

The MHT100 Setup Mode Source Settings allow any of the seven Analog Audio/Video Inputs, six Digital Audio Inputs and two Component Video Inputs to either be reassigned and/or retitled from the default settings. For example, AUX can be retitled as DVD2. When the Input selector is rotated to select what was originally AUX Input, DVD2 will now appear on the Front Panel Alphanumeric Display as well as on the Monitor/TV.

The Setup Mode Source Setting will also allow for the adjustment of volume levels for each of the Analog Audio Inputs. This Input Trim can be used so there is little to no overall volume differences when switching between Analog Input Sources.

*Note: If the MHT100 has the Tuner Module installed, the Source Input number 8 will always be assigned to the Tuner.*

1. Press and hold the Front Panel SETUP Push-button approximately three seconds to enter the Setup Mode. The word SETUP will appear on the MHT100 Front Panel Display and the MAIN SYSTEM SETUP Menu will appear on the Monitor/TV screen. Refer to figure 12 on page 25.
2. Using the Up▲ or Down▼ directional push-buttons select Source Settings on the On-Screen Menu, followed by the SELECT Push-button on the Remote Control.
3. Using the Up▲ or Down▼ directional push-buttons select Number 1 SOURCE INPUT from the On-Screen Menu, followed by pressing the Left◀ or Right▶ directional push-buttons to select the desired Input Number for reassignment. Refer to figure 24.

*Note: The very first time the SOURCE SETTINGS are accessed, the factory default settings will be indicated.*

### Title

4. Using the Left◀ or Right▶ directional push-buttons select Number 2 followed by pressing the SELECT Push-button. The On-Screen Menu will now change, allowing the current Input Title Name to be altered. Refer to figure 25.
5. The On-Screen Display will show an arrow↑ underneath the left most character of the current Input Title Name. Press the Up▲ or Down▼ directional push-buttons to select the desired character from the available characters that include the alphabet, numbers and symbols.
6. To change the next character press the Right▶ directional push-button to move the arrow to change the next character. Press the Up▲ or Down▼ directional push-buttons again to select the desired character.

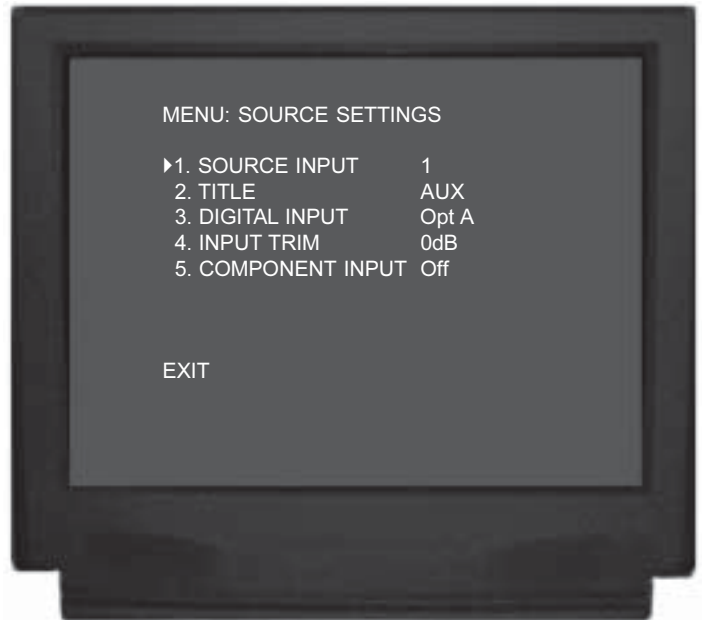

Figure 24

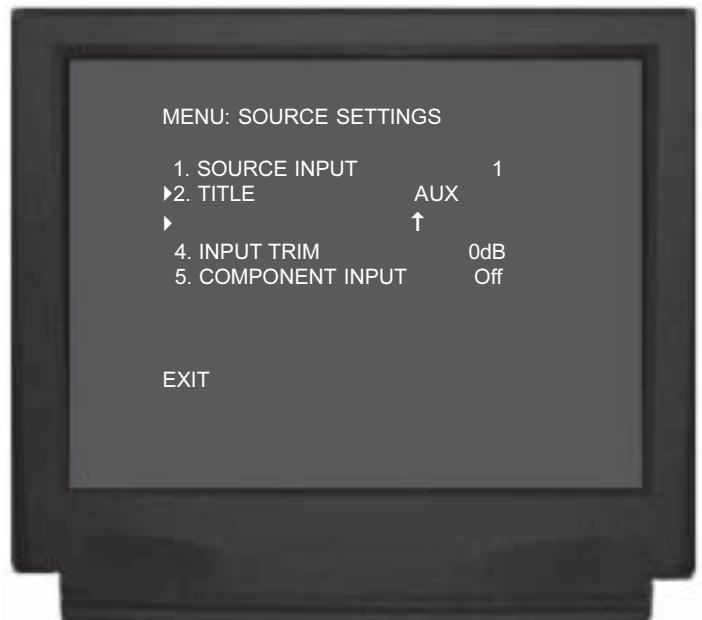

Figure 25

7. Repeat step 6 until the desired Input Title Name is complete.

*Note: The Input Title Name can be up to six characters long. If you would like the changes in titles to be reflected when operating by remote control ask your dealer about the McIntosh UR12 Touch Screen Remote Control which has retitling capabilities.*

**Digital Input**

There are three Optical Digital Inputs and three Coaxial Digital Inputs available for assignment with any of the seven Analog Audio Inputs. The following example describes how to reassign Digital Input A, which by default has been assigned to AUX Input, over to the VCR2 Input instead.

8. Using the Up▲ or Down▼ directional push-buttons select Number 1 SOURCE INPUT from the On-Screen Menu, followed by pressing the Left◀ or Right▶ directional push-buttons to select the AUX Input, Number 1. Refer to figure 24.

9. Using the Up▲ or Down▼ directional push-buttons select DIGITAL INPUT on the On-Screen Menu, followed by pressing the Left◀ or Right▶ directional push-buttons to select OFF.

*Note: The default setting for the AUX Digital Input is OPTical A.*

10. Using the Up▲ or Down▼ directional push-buttons select Number 1 SOURCE INPUT from the On-Screen Menu, followed by pressing the Left◀ or Right▶ directional push-buttons to select the VCR2 Input.

11. Using the Up▲ or Down▼ directional push-buttons select DIGITAL INPUT on the On-Screen Menu, followed by pressing the Left◀ or Right▶ directional push-buttons to select OPTical A.

*Note: The default setting for the VCR2 Digital Input is OFF.*

**Input Trim**

Analog Audio Source components can have slightly different volume levels. This could result in the constant need to readjust the MHT100 Volume

Control when switching between different Program Sources. A volume trim feature on the MHT100 allows you to adjust or trim the levels of the various inputs so that they have the same relative volume. The Default Trim Setting for all Inputs is 0dB and each input has a range of adjustment in Trim Volume Level from +3dB to -6dB. The Tuner is a frequently listened to source and makes a good reference for comparing the volume between different inputs. It is helpful to note first, before beginning the adjustments, which inputs have volume levels that are louder or quieter than the Tuner Input. In the example below, the audio from the AUX Input Source is louder than the sound from the Tuner Input:

*Note: The Input Trim Level Adjustment only affects Audio Source Components connected to the Left and Right Analog Inputs. There is no effect on the volume levels from Digital Audio Sources Components connected to one of the Digital Inputs. The Record Output Levels are unaffected by any changes in the Input Trim Setting.*

12. Using the Up▲ or Down▼ directional push-buttons select Number 1 SOURCE INPUT from the On-Screen Menu, followed by pressing the Left◀ or Right▶ directional push-buttons to select the AUX Input, Number 1. Refer to figure 24.

Analog Audio and Video Inputs Source Settings				
Source Number	Default Title	New Title	Default Trim	New Trim
1	AUX		0dB	
2	CD		0dB	
3	SAT		0dB	
4	TV		0dB	
5	DVD		0dB	
6	VCR 1		0dB	
7	VCR 2		0dB	
8	TUNER		0dB	

Digital Audio Source Settings				
Source Letter	Default Input Number	Default Input Name	New Input Number	New Input Name
A(Optical)	1	AUX		
B(Optical)	2	CD		
C(Optical)	3	SAT		
D(Coaxial)	4	TV		
E(Coaxial)	5	DVD		
F(Coaxial)	6	VCR 1		

13. Using the Up▲ or Down▼ directional push-buttons select Number 4 INPUT TRIM on the On-Screen Menu, followed by pressing the Left◀ or Right▶ directional push-buttons to select.
14. Using the Left◀ directional Push-button select -3dB for the new INPUT TRIM Level. Select EXIT on the menu and the MAIN SYSTEM SETUP Menu will reappear on the Monitor/TV screen.
15. Select EXIT from the MAIN SYSTEM SETUP Menu, select YES to save the changes and the MHT100 will then return to normal operation.
16. Compare the new AUX Input Volume Level to the Tuner Volume Level. If the AUX Input Volume Level is still louder than the Tuner perform the Source Setting step 1 and then steps 12 through 16. When the volume level on the AUX Input is about the same as the Tuner Input, perform the Input Trim Adjustments for any other Inputs that are quieter or louder than the Tuner.

### Component Input

The MHT100 has Electronic Input Switching for two Component Video Sources. The default assignments for the two inputs can be changed to match up with the two Component Video Sources in your system. The following example describes how to reassign COMPONENT 1 IN Video Input, which by default has been assigned to SAT Input, over to the VCR1 Input instead.

17. Using the Up▲ or Down▼ directional push-buttons select Number 1 SOURCE INPUT from the On-Screen Menu, followed by pressing the Left◀ or Right▶ directional push-buttons to select the SAT Input, Number 3. Refer to figure 26.
18. Using the Up▲ or Down▼ directional push-buttons select Number 5 COMPONENT INPUT on the On-Screen Menu, followed by pressing the Left◀ or Right▶ directional push-buttons to select OFF.
19. Using the Up▲ or Down▼ directional push-buttons select Number 1 SOURCE INPUT from the On-Screen Menu, followed by pressing the Left◀ or Right▶ directional push-buttons to select the VCR2 Input.
20. Using the Up▲ or Down▼ directional push-buttons select Number 5 COMPONENT INPUT on the On-

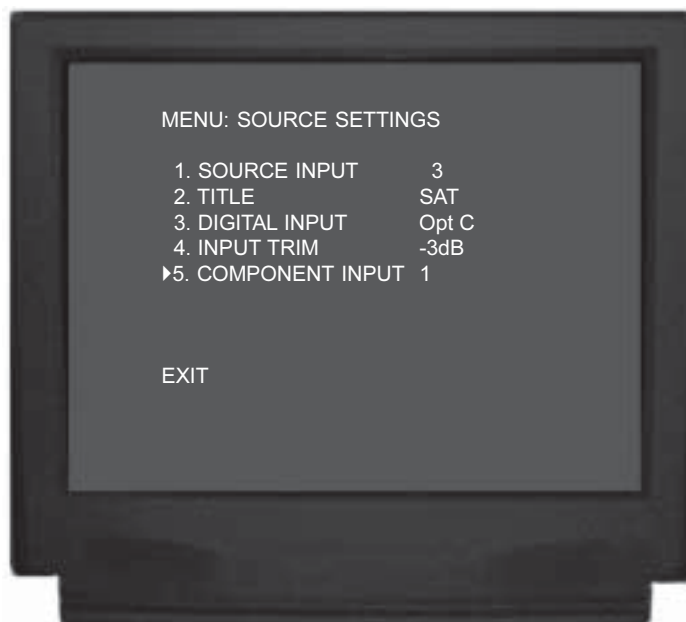

Figure 26

- Screen Menu, followed by pressing the Left◀ or Right▶ directional push-buttons to select Number 1. Select EXIT on the menu and the MAIN SYSTEM SETUP Menu will reappear on the Monitor/TV screen.
21. Continue next to the VIDEO POWER CONTROL. If you do not wish to perform VIDEO POWER CONTROL Adjustments at this time, proceed to the next step.
  22. Select EXIT from the MAIN SYSTEM SETUP Menu. If you are satisfied with the changes that you may have made, select YES to save those changes or NO not to save them. The MHT100 will then return to normal operation. Refer to figure 13 on page 25.

Component Video Source Settings				
Source Number	Default Input Number	Default Input Name	New Input Number	New Input Name
1 IN	3	SAT		
2 IN	5	DVD		

## How to Assign Video Power Control

The MHT100 VIDEO POWER CONTROL Setup allows selecting a specific Video Input or all Video Inputs to activate the VIDEO POWER CONTROL Jack. This can be used to switch AC Power using McIntosh AC Power Controllers and other devices. There are several options available for the Turn-on Signal that include Voltage Polarity, Time Delay and Duration. The settings for activation of the Power Control Jack include Input Source Selection, whether the component to be Turned-On requires a positive or negative going control signal, if the signal will be delayed and for the duration of the signal.

1. Press and hold the Front Panel SETUP Push-button approximately three seconds to enter the Setup Mode. The word SETUP will appear on the MHT100 Front Panel Display and the MAIN SYSTEM SETUP Menu will appear on the Monitor/TV screen. Refer to figure 12 on page 25.
2. Using the Up▲ or Down▼ directional push-buttons select Number 6 Video Power Control on the On-Screen Menu, followed by the SELECT Push-button on the Remote Control.

### Input

3. Using the Up▲ or Down▼ directional push-buttons select Number 1 INPUT from the On-Screen Menu, followed by pressing the Left◀ or Right▶ directional push-buttons to select the desired Input, PowerOn (will supply the Turn-On Signal whenever Zones A or B of the MHT100 is On) or Video Power Control Off. Refer to figure 27.

### Polarity

4. Using the Up▲ or Down▼ directional push-buttons select Number 2 POLARITY on the On-Screen Menu, followed by pressing the Left◀ or Right▶ directional push-buttons to select Positive or Negative going Turn-On Signal.

*Note: All McIntosh Models use a positive going Turn-On Signal.*

### Delay

5. Using the Up▲ or Down▼ directional push-buttons select Number 3 DELAY on the On-Screen Menu, fol-

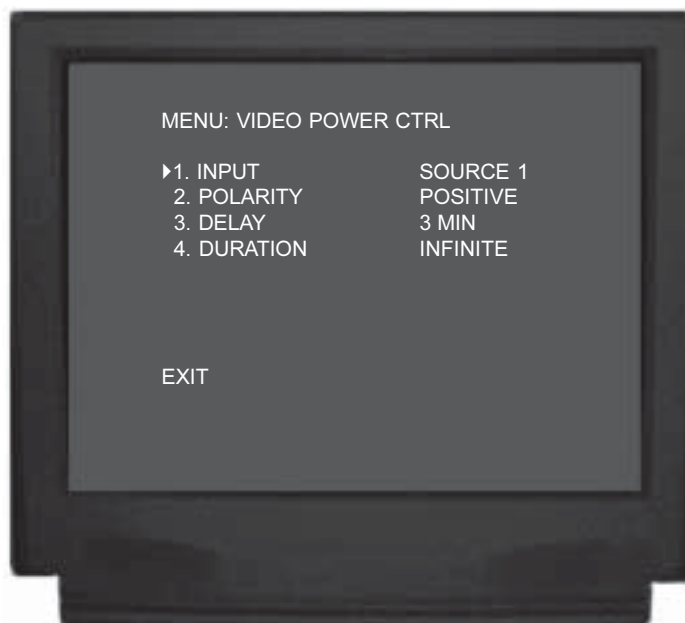

Figure 27

lowed by pressing the Left◀ or Right▶ directional push-buttons to select the desired Turn-On Signal Time Delay.

### Duration

6. Using the Up▲ or Down▼ directional push-buttons select Number 4 DURATION on the On-Screen Menu, followed by pressing the Left◀ or Right▶ directional push-buttons to select the desired amount of time the Turn-On Signal will be present. Select EXIT on the menu and the MAIN SYSTEM SETUP Menu will reappear on the Monitor/TV screen.
7. Continue next to the TUNER PRESETS on page 53 or if you do not wish to perform TUNER PRESETS Adjustments at this time, proceed to the next step.
8. Continue next to the SYSTEM SETUP or you do not wish to perform SYSTEM SETUP Adjustments at this time, proceed to the next step.
9. Select EXIT from the MAIN SYSTEM SETUP Menu.

If you are satisfied with the changes that you may have made, select YES to save those changes or NO not to save them. The MHT100 will then return to normal operation. Refer to figure 13 on page 25.

Video Power Control Settings		
Power Control	Default Setting	New Setting
Input	PowerOn	
Polarity	Positive	
Delay	None	
Duration	Infinite	

## How to change System Setup

The MHT100 is marketed all over the world. The SYSTEM SETUP allows for selection of the proper Video Format Standard for the On-Screen Displays. If the AM/FM Tuner Module is installed there are also selections to match the Tuner Functioning with the Radio Broadcasts in your country. There are two different types of On-Screen Displays.

1. Press and hold the front panel Setup Push-button approximately three seconds to enter the Setup Mode. The word SETUP will appear on the MHT100 Front Panel Display and the MAIN SYSTEM SETUP Menu will appear on the Monitor/TV screen. Refer to figure 12 on page 25.
2. Using the Up▲ or Down▼ directional push-buttons select Number 8 System Settings on the On-Screen Menu, followed by the SELECT Push-button on the Remote Control. Refer to figure 27.

### Video

3. Using the Up▲ or Down▼ directional push-buttons select Number 1 VIDEO from the On-Screen Menu, followed by pressing Left◀ or Right▶ directional push-buttons to select either NTSC or PAL Video Format.

*Note: If the TV/Monitor stops displaying the On-Screen Setup properly, just press the Left◀ or Right▶ directional push-button a second time.*

### Tuner

4. The On-Screen Menu Item Number 2 indicates the countries the TM1 AM/FM Tuner Module is set for.

### Temp Display

5. Using the Up▲ or Down▼ directional push-buttons select Number 3 TEMP DISPLAY from the On-Screen Menu, followed by pressing Left◀ or Right▶ direc-



Figure 27

- tional push-buttons to select either OFF, SIMPLE or FULL On-SCREEN Display Information. The SIMPLE On-SCREEN Display Information will include Zone A Input Selection and Volume. The FULL On-SCREEN Display Information will include the SIMPLE Display Information for Zone A plus additional Audio/Video Input Information. Select EXIT on the menu and the MAIN SYSTEM SETUP Menu will reappear on the Monitor/TV screen.
6. Select EXIT from the MAIN SYSTEM SETUP Menu. If you are satisfied with the changes that you may have made, select YES to save those changes or NO not to save them. The MHT100 will then return to normal operation. Refer to figure 13 on page 25.

System Setup			
	Default Settings		
Adjustment	North America	Other Country	New Setting
Video	NTSC		
Tuner	USA		
Temp Display	Full	Full	

## How to Operate the MHT100

The McIntosh MHT100 has been factory configured for default operating settings that will allow immediate enjoyment of superb video and high fidelity audio without the need for further adjustments. If you wish to make changes to the factory default settings refer to the SETUP Section of this Owner's Manual.

### Power On and Off

Press the POWER switch to ON and the Red LED above the STANDBY/ON Push-button illuminates, to indicate the MHT100 is in Standby Mode. Switch On the MHT100 by pressing the STANDBY/ON Push-button. The title MHT100 will appear on the Front Panel Alphanumeric Display for approximately two seconds, with the Loudspeakers muted. Refer to figures 28, 29 & 30.



Figure 28

*Notes: For normal operation, turn the MHT100 On and Off with the Standby/On Push-button. You may also switch On the MHT100 by simply pressing the Power Push-button on the Remote Control. If the A/V System Controller is not going to be used for an extended period of time, turn Off all AC Power with the Power Switch. If the MHT100 is in the Standby Mode and Zone B is active the Front Panel Alphanumeric Display will indicate ZONE B ON. Refer to "How to Operate Zone B" on page 47 for additional information.*

### Input Selector

The INPUT Selector Switch selects the Listening/Viewing Program Source for Zone A with the selected choice indi-

cated on the left side of the Front Panel Alphanumeric Display. Refer to figure 29.

*Note: The INPUT Selector Switch also selects the Record Output for recording and the Zone B Listening/Viewing Program Source. Refer to "How to Make a Recording" on page 42 and "How to Operate Zone B" on page 47 for additional information.*

### Volume Control

The VOLUME Control allows adjustment of the Listening Level for all the Zone A Channels, with the indication of the relative volume level displayed on the right side of the Front Panel Alphanumeric Display. Refer to figure 29.

*Notes: The VOLUME Control can also adjust the Zone B Listening/Viewing Program Source, once the Zone is active. Refer to "How to Operate Zone B" on page 47 for additional information. The maximum indicated volume level will vary.*



Figure 30



Figure 29

depending on the settings of the individual TRIM Levels and SURROUND Mode.

## System Off

Normally, each Zone is turned On and Off individually by pressing the Power Push-button on a Keypad or Remote Control. If you desire to switch Off both Zones of the McIntosh MHT100 A/V System Controller and connected accessory source components, press the SYS OFF Push-button on the Front Panel. Refer to figure 31.

*Note: The Sys Off Push-button on a Keypad or Remote Control may also be used to turn Off the entire system.*

## Zone B

First press the Zone B Push-button, then rotate the INPUT Selector Switch for selecting the source that is available for Listening/Viewing in Zone B and at the AUDIO RECORD OUTPUT jacks for recording. If Zone A is active, pressing the Zone B Push-button followed by the STANDBY/ON Push-button will either Turn-On Zone B or Turn-Off if Zone B is already active.

*Notes: About five second after pressing the ZONE B Push-button and/or no other Front Panel Control or Push-button is engaged after pressing the ZONE B Push-button, the ZONE B Control Access will be switched Off and the LED above the push-button will extinguish. Refer to "How to Operate Zone B" on page 47.*

## Setup

Pressing the SETUP Push-button activates the MHT100 SETUP Mode for making changes to the Home Theater System.

## Tune ▲▼

Rotate the TRIM SELECT Switch to the TUNE Position

and then press the TUNE Up▲ or Down▼ Push-buttons, this allows for selection of the next Preset FM/AM Radio Station that has been stored into memory or scanning the FM/AM Broadcast Band when the optional TM1 Tuner Module is installed. Refer Tune on page 53 for additional information.

## Late Night

The LATE NIGHT Push-button turns a volume compression circuit on and off. This feature suppresses loud sounds or music that might disturb neighbors or others not in the immediate area of the Home Theater. Soft levels are also raised slightly so they can still be heard at the reduced volume levels. This works only on a Dolby Digital Sound Track with encoded data that supports the compression function. Refer to figure 31.

## Front Panel Status

The four Front Panel LEDs indicate the status of the Operating/Decoding Modes. Refer to figure 31.

## Operating Mode Displays

- The DOLBY DIGITAL Display will illuminate when the input contains Dolby Digital Encoded Signals.
- The PRO LOGIC Display will illuminate when the Surround Mode Selector is turned to CINEMA 1 or CINEMA 2 and the Input Signal is Dolby Surround Encoded.
- The DTS Display will illuminate when the input contains DTS Encoded Signals.
- The EXPAND (Reference) Display will illuminate when the Surround Mode Selector is turned to CINEMA 2 or the MUSIC 4 Modes.



Figure 31



**On-Screen Display**

The MHT100 has a Dynamic On-Screen Display making it easy to know the operating status without referring to the Front Panel.

Press the current Source Selected Input Push-button on the McIntosh Remote Control and the On-Screen Display will appear on the TV/Monitor. It will also appear when changing Source using the INPUT Selector and when the Digital Processor changes modes. Figure 32 illustrates a typical Full On-Screen Display, with the DVD Input Selected and the Volume Level being adjusted.

*Note: In order for the On-Screen Display to function the SYSTEM SETUP TEMP DISPLAY must be set to Full. Refer to the System Setup on page 38.*

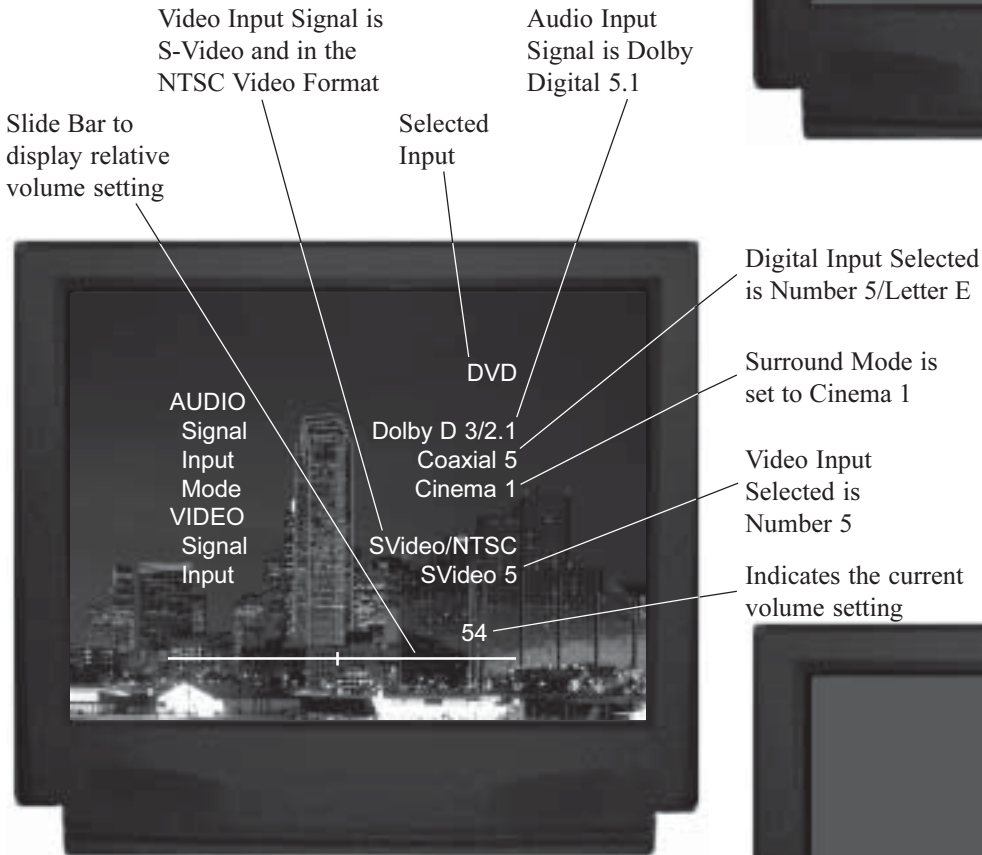

Figure 32

When the MHT100 has the optional TM1 AM/FM Tuner Module installed, the On-Screen Display will indicate the Frequency and Preset Label. Press the Front Panel TRIM/TUNE Push-buttons or the REVIEW Push-button on the Remote Control and the Preset Label will appear on the bottom of the On-Screen Display. The Frequency of the Station will appear when using the Channel Up and Down Push-buttons. The On-Screen Display will also indicate the TRIM MODE adjustments of either the Channel Levels or Tone settings. Refer to figures 33 and 34.



Figure 33

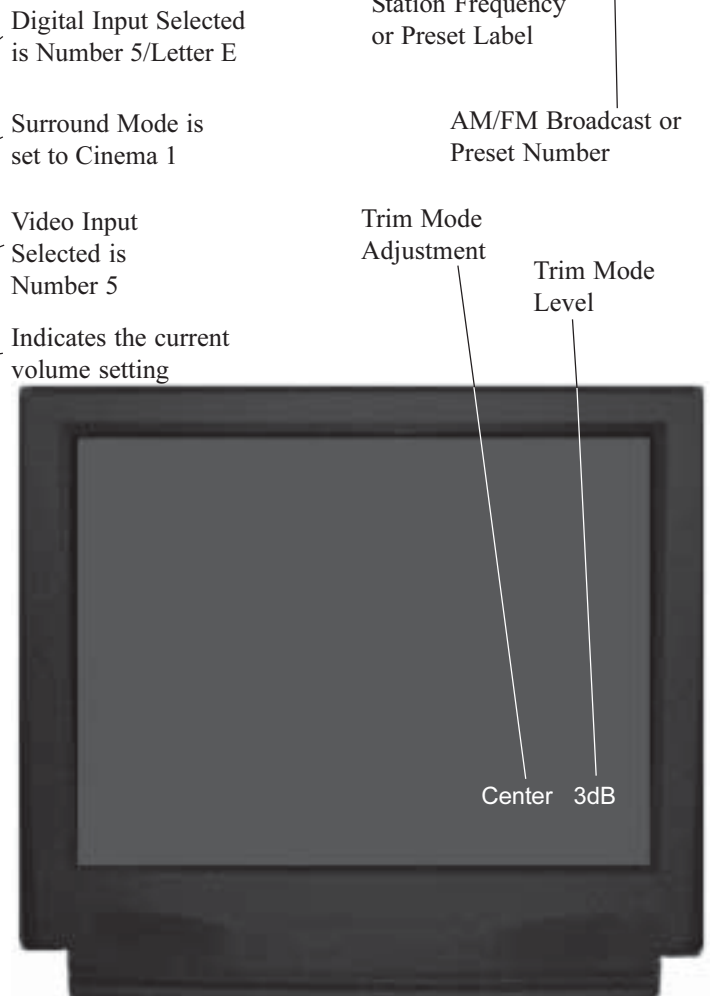

Figure 34

## How To Make A Recording

The INPUT Selector Switch together with the Zone B Push-button allows the making of a recording from one program source while listening to another. You can also listen (monitor) to the recorded signal off the tape, a fraction of a second later, during recording when a three head tape recorder is used. Refer to figure 38.

1. Press the ZONE B Push-button, the LED above the button will illuminate. Refer to figure 35.
2. Rotate INPUT Selector Switch until the desired Input has been selected. Refer to figures 36 and 37.

*Note: The INPUT Selector Switch will return to ZONE A Input Selection, about five seconds after the ZONE B Push-button is pressed and the INPUT Selector is no longer being rotated.*

3. Adjust the record level using the recorder's volume control.



Figure 35



Figure 36



Figure 37

4. To monitor the tape during recording with a three head tape recorder, or playback the tape just recorded, turn the INPUT Selector Switch to select the recorder used.

*Note: The MHT100 RECORD OUTPUTS are not affected by the VOLUME control. To listen to a different program source while recording, turn the INPUT Selector Switch to the desired source. The recording process will not be affected and will continue.*



Figure 38

## How to Operate the Trim Mode

The MHT100 TRIM SELECT Switch together with the TRIM LEVEL Control provide the means for adjusting five different audio functions and the Front Panel Alphanumeric Display Brightness. This can be accomplished from either the Front Panel Controls or with the supplied Remote Control very conveniently from the Listening/Viewing Area. The Front Panel Alphanumeric Display indicates the Trim Mode Selected and Trim Levels. You can create the sound quality that you prefer while listening to music or a movie sound track. Refer to figures 38 & 41.

*Note: The following Trim Instructions refer only to Trim Setting Examples performed using the Remote Control; make any Trim Adjustments based on your own preferences.*

### Loudspeaker Volume Levels

The Volume Levels of the Center, Subwoofer and Surround Loudspeakers can be adjusted up or down by 12dB relative to the Left and Right Front Loudspeakers. Any Surround Trim level adjustments made will revert back to the Setup Loudspeaker Levels when the MHT100 is turned off.

1. Press and release the TRIM Push-button on the Remote Control until SUB TRIM appears on the front panel display. Refer to figures 39 and 40.

*Notes: 1. You can also perform all TRIM functions using the Front Panel TRIM SELECT Control and TRIM Up ▲ and Down ▼ Push-buttons.*

2. Low Frequency Information must be present in the Program Source



Figure 40



Figure 39

*Material in order to hear any changes in the Subwoofer Loudspeaker Levels.*

2. Press the LEVEL Up ▲ Push-button until +5 appears to the right of SUB TRIM on the Front Panel Display. This is an example of increasing the Subwoofer level by 5dB.
3. Press and release the TRIM Push-button until SURR TRIM appears on the front panel display. Refer to figure 42.



Figure 41



Figure 42

4. Press the LEVEL Down ▼ Push-button until the -10 appears to the right of SURR TRIM on the Front Panel Display. This is an example of decreasing the Surround Loudspeakers Levels by -10dB.
5. Press and release the TRIM Push-button until CNTR TRIM appears on the Front Panel Display. Refer to figure 43.



Figure 43

6. Press and release LEVEL Up ▲ Push-button until the + 3 appears to the right of CNTR TRIM on the Front Panel Display. This is an example of increasing the Center Loudspeaker Level by +3dB.

*Notes: The TRIM SELECT Mode will stay active until either the TRIM SELECT Control is set to OFF, a Front Panel Control is rotated or Push-button is pressed. The TRIM Mode can also be switched Off by pressing the TRIM Push-button on the Remote Control until the TRIM Mode Selector Control reaches the Off position.*

## Bass and Treble

The MHT100 allows for changing the tonal response for any of the eight sources via the BASS and TREBLE TRIM Adjustments. Any tonal changes made are saved in permanent memory. The Bass and Treble Tonal Response can be adjusted up or down by 12db from the Flat Setting.

*Note: The TRIM Adjustments may be performed from either the Front Panel or by Remote Control. The TRIM Adjustment examples below are performed by using the Remote Control.*

1. Press and release the TRIM Push-button on the Remote Control until BASS TRIM appears on the Front Panel Alphanumeric Display. Refer to figure 44.



Figure 44

2. Press and release the LEVEL Up▲ Push-button until the +10 appears to the right of BASS TRIM on the Front Panel Alphanumeric Display. This is an example of increasing the Bass response by +10dB.
3. Press and release the TRIM Push-button until TREB TRIM appears on the Front Panel Alphanumeric Display. Refer to figure 45.



Figure 45

4. Press and release the LEVEL Up▲ Push-button until the +11 appears to the right of TREB on the Front Panel Alphanumeric Display. This is an example of increasing the Treble response by +11dB.

## Display Brightness

The MHT100 Trim feature allows adjustments to the brightness of the Front Panel Alphanumeric Display to the desired intensity. The Display Trim brightness range extends from Off to a maximum of 10.

*Note: You may find it easiest to make Display adjustments with the Front Panel Controls.*

1. Press and release the TRIM Push-button on the Remote Control, or rotate the TRIM SELECT Control, until DISPLAY appears on the Front Panel Alphanumeric Display. A number to the right of the display indicates the current brightness level. Refer to figure 46.



Figure 46

2. Press a LEVEL Up▲ or Down▼ Push-button on the Remote Control, or rotate the TRIM LEVEL Control, until you reach the desired display brightness.

## How to Operate the Surround Mode

The MHT100 provides eight different Surround Modes.

The Front Panel Alphanumeric Display indicates the Surround Mode selected. The Surround Mode Selected is stored into permanent memory and automatically



Figure 47

recalled any time that particular input is selected again. If the Surround Mode is changed when the input is again selected, the new mode will be active and stored. Refer to figure 47.

*Note: The Remote Control may also be used to make changes to the Surround Modes. Refer to figure 51.*

*Approximately 3 seconds after selecting a new Surround Mode Setting the Front Panel Alphanumeric Display will change from indicating that mode to the normal display of Input and Volume.*

### Stereo

Analog Input Signals Sources are sent to the Left and Right Loudspeakers. All Multi-channel Signal Sources are combined and reduced to 2 channels in the Stereo Mode. Refer to figures 47 and 48.



Figure 48

### Music 1

This processing mode creates an effect of natural ambient time delay similar to listening in a very large room or a medium size hall. A Difference Signal is created from the Left and Right Front Channels. The Difference Signal is delayed a medium amount of time and is sent to the Left and Right Surround Loudspeakers. The Front Panel Alphanumeric Display will indicate MUSIC 1. Refer to figures 47 and 49.



Figure 49

### Music 2

This processing mode creates an effect of natural ambient time delay similar to listening in a small room. A Difference Signal is created from the Left and Right Front Channels. The Difference Signal is delayed for a short time and



Figure 50

is sent to the Left and Right Surround Loudspeakers. The Front Panel Alphanumeric Display will indicate MUSIC 2. Refer to figures 47 and 50.

### Music 3

This processing mode creates an effect of natural ambient time delay similar to listening in a small room with a softer sound. A Difference Signal is created from the Left and Right Front Channels. The Difference Signal is delayed for a medium amount of time and is sent to the Left and Right Surround Loudspeakers. The Front Panel Alphanumeric Display will indicate MUSIC 3. Refer to figures 47 and 52.

### Music 4

This processing mode creates an effect of time delay similar to listening in a very large hall or outside. A Difference Signal is created from the Left and Right Front Channels. The Difference Signal is delayed for a medium amount of time and is sent to the Left and Right Surround Loudspeakers. The Front Panel Alphanumeric Display will indicate MUSIC 4 and the Front Panel EXPAND Indicator will be illuminated. Refer to figures 47 and 53.



Figure 51



Figure 52



Figure 53

## Cinema 1

This provides decoding of Dolby Pro Logic Analog or Digital Signals and decoding of Dolby Digital or DTS Signals. The Front Panel Alphanumeric Display will indicate CINEMA 1 and the appropriate Front Panel Operating Mode Display LEDs will illuminate. Refer to figures 47 and 54.



Figure 54

## Cinema 2

This provides decoding of Dolby Pro Logic Analog or Digital Signals, decoding of Dolby Digital or DTS Signals and Back Surround Channel information. The Front Panel Alphanumeric Display will indicate CINEMA 2 and the appropriate Front Panel Operating Mode Display LEDs and the EXPAND LED will illuminate. Refer to figures 47 and 55.



Figure 55

## External

All internal signal processing is bypassed and the eight Rear Panel EXTERNAL INPUTS are activated so the MHT100 performs as an eight channel preamplifier for an external source or processor. The Front Panel Alphanumeric Display indicates EXTERNAL. Refer to figures 47 and 56.



Figure 56

## How to Operate Zone B

The MHT100 includes the capability of being able to operate and control two audio/video zones, independently of each other. Zone A is the Primary (Home Theater Listening Area) with Surround Sound, Zone B is configured for a Secondary Remote Location providing two channel audio and video programs.

The program source selected for Zone A appears on the left side of the MHT100 Front Panel Alphanumeric Display, refer to figure 57. Program source selected for Zone B appears on the right side of the Alphanumeric Display, refer to figure 58. Zone A Sources are selected by using the INPUT A (Listen) Selector Switch and the Zone B Sources are selected by using the INPUT B (Record) Selector Switch. Refer to figure 62.

*Note: Approximately 3 seconds after selecting a new Zone B Input and/or Volume Change the Front Panel Alphanumeric Display will change from indicating Zone B display of Input and Volume to Zone A's current Input and Volume.*



Figure 57



Figure 58

1. Zone B may be Turned On or Off by pressing the POWER Push-button on the Keypad or using a Remote Control aimed at a Sensor located in Zone B. When Zone B is turned-on the MHT100 Front Panel Alphanumeric Display will indicate ZONE B ON if Zone A is not active. Refer to figures 59, 60 and 61.

*Notes: If Zone A is On, Zone B may be switched On or Off from the MHT100 Front Panel by first pressing the ZONE B Push-button and immediately pressing the STANDBY/ON Push-button. Zones A and B may be switched Off by pressing the SYS Push-button on the Keypad, using the Remote Control or the MHT100 Front Panel.*



Figure 59

2. Select the desired Zone B Source and adjust the Volume to the desired listening level by pressing the appropriate push-buttons on the Keypad or Remote Control. Refer to figures 60, 61 and 62.

*Note: If Zone A is On, Zone B Input may be changed from the MHT100 Front Panel by first pressing the ZONE B Push-button and then rotating the INPUT Selector Control until the desired source is selected.*

3. If a McIntosh Disc Player is connected to the MHT100, most operating functions can be performed with the keypad or Remote Control.



Figure 60



Figure 61



Figure 62

### Preamplifier and Processor Specifications

#### Frequency Response

STEREO	Left and Right Loudspeakers: +0 -0.5dB from 20Hz-20,000Hz
MUSIC 1-4	Left, Center, Right Loudspeakers: +0 -0.5dB from 20Hz-20,000Hz Large Surround Loudspeakers: +0 -0.5dB from 20Hz-20,000Hz
PROLOGIC	Left, Center, Right, Large Loudspeakers: ±0.5dB from 20Hz-20,000Hz Large Surround Loudspeakers: +1 -3dB from 20Hz-6.3kHz Subwoofer <sup>1and2</sup> : 20Hz-140Hz
Dolby Digital, DTS and EXTERNAL INPUT	Left, Center, Right Large Loudspeakers: ±0.5dB from 20Hz-20,000Hz Large Surround Loudspeakers: ±0.5dB from 20Hz-20,000Hz Subwoofer <sup>1and2</sup> : 20Hz-140Hz

#### Rated Output

2V for all channels

#### Input Impedance

22K ohms

#### Output Impedance

Less than 560 ohms for all channels

#### Maximum Output Voltage

8V

#### Total Harmonic Distortion

0.05% for all channels

#### Sensitivity

Analog Input:	100mV IHF
Dolby Level	200mV Input
External Input	200mV for 2.0V output

#### Signal To Noise Ratio

Greater than 90dB A weighted

#### Maximum Input Signal

Analog Input: 6Vrms

#### Tone Controls

±12dB from the flat setting

<sup>1</sup> If any of the Channels have the Loudspeaker Setting of Small, the subwoofer has a electronic low pass filter with a corner frequency of 80Hz and a 24dB per Octave rolloff in all modes except external.

<sup>2</sup> The Frequency Response of the Subwoofer Channel is also determined by the Crossover Setting.



### Power Amplifier Specifications

---

#### Power Output

Minimum sine wave continuous average power output per channel, all channels operating is:

- 100 watts into a 4 ohm load
- 70 watts into a 8 ohm load

#### Rated Power Band

20Hz to 20,000Hz

#### Total Harmonic Distortion

Maximum Total Harmonic Distortion at any power level from 250 milliwatts to rated power output is:

0.05% for 4 or 8 ohm load

#### Dynamic Headroom

1.8dB

#### Frequency Response

- +0, -0.25dB from 20Hz to 20,000Hz
- +0, -3dB from 10Hz to 100,000Hz

#### Sensitivity

1.0 Volt

#### A-Weighted Signal To Noise Ratio

92dB (112dB below rated output)

#### Intermodulation Distortion

Maximum Intermodulation Distortion if instantaneous peak output per channel does not exceed twice the rated output, for any combination of frequencies from 20Hz to 20,000Hz, with all channels operating is:

0.05% for 4 or 8 ohm loads

#### Input Impedance

20,000 ohms

#### Wide Band Damping Factor

- 100 at 4 ohms
- 200 at 8 ohms

### General Specifications

---

#### Power Requirements

- 100 Volts, 50/60Hz at 8.4 Amps
- 110 Volts, 50/60Hz at 7.7 Amps
- 120 Volts, 50/60Hz at 7.0 Amps
- 220 Volts, 50/60Hz at 3.5 Amps
- 230 Volts, 50/60Hz at 3.5 Amps
- 240 Volts, 50/60Hz at 3.5 Amps

*NOTE: Refer to the rear panel of the MHT100 for the correct voltage.*

#### Dimensions

Front Panel: 17-3/4 inches (45.09cm) wide, 9-7/16 inches (23.97cm) high. Depth behind front mounting panel is 19 inches (48.26cm) including clearance for connectors. Panel clearance required in front of mounting panel is 1-1/8 inches (2.9cm).

#### Weight

73 pounds (160.9Kg) net, 87 pounds (191.8Kg) shipping

## TM1 AM/FM Tuner Module

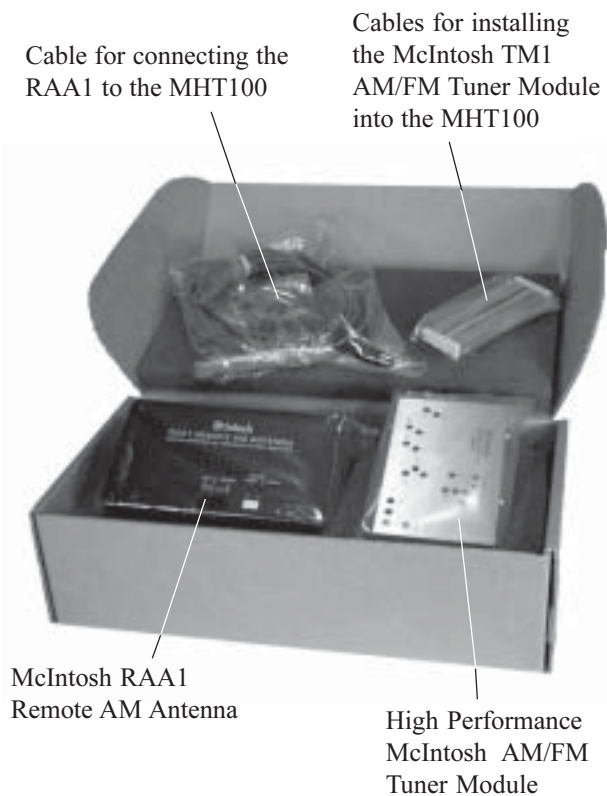

### Introduction

When the MHT100 A/V System Controller is sold outside of North America, the optional McIntosh TM1 AM/FM Tuner Module can be added for Radio Broadcast Reception. The TM1 delivers the same exceptional performance as the stand-alone McIntosh MR85 Tuner. The TM1 is available from your McIntosh Dealer and can be installed at any time, usually while you wait.

### Performance Features

- **Special FM RF Amplifier**

Double-Diffused Metal Oxide Field Effect Transistor (DMOS-FET) RF amplifier increases sensitivity and Cross Modulation rejection.

- **External AM RF Amplifier and Antenna**

The TM1 includes a RAA1 Remote AM Antenna that contains an electrostatically shielded AM RF Amplifier Stage for maximum noise rejection. It can be located in a remote area, away from sources of interference and can be positioned for the best possible reception of even the weakest AM stations.

- **FM Stereo Auto Blend Circuitry**

An automatic variable stereo separation control circuit is used to reduce background noise when receiving weak stereo stations.

- **Preset Stations and Permanent Memory**

Nine AM and nine FM Station Presets, making it easy to listen to your favorite stations. Station Presets and Functions Modes are retained in Permanent Memory even when AC power is turned off.

- **Alphanumeric Fluorescent Display**

The MHT100 Multi-function Front Panel Display indicates station frequency, station preset number, signal strength, stereo and broadcast band.

### TM1 Table of Contents

Introduction .....	50
Performance Features .....	50
MHT100 Rear and RAA1 Top Panels	
Antenna Connections .....	51
How to Connect Antenna Components .....	52
How to Assign Preset Stations .....	53
How to Operate the Tuner .....	55
How to Optimize AM Reception .....	56
FM Specifications .....	57
AM Specifications .....	57

# MHT100 Rear Panel and RAA1 Top Panel Antenna Connections

RAA1 Remote Antenna can be adjusted to a position for optimum reception of your favorite AM stations

Connects with supplied cable to the MHT100



AM ANT (Antenna) connector allows a McIntosh Remote Antenna to be connected

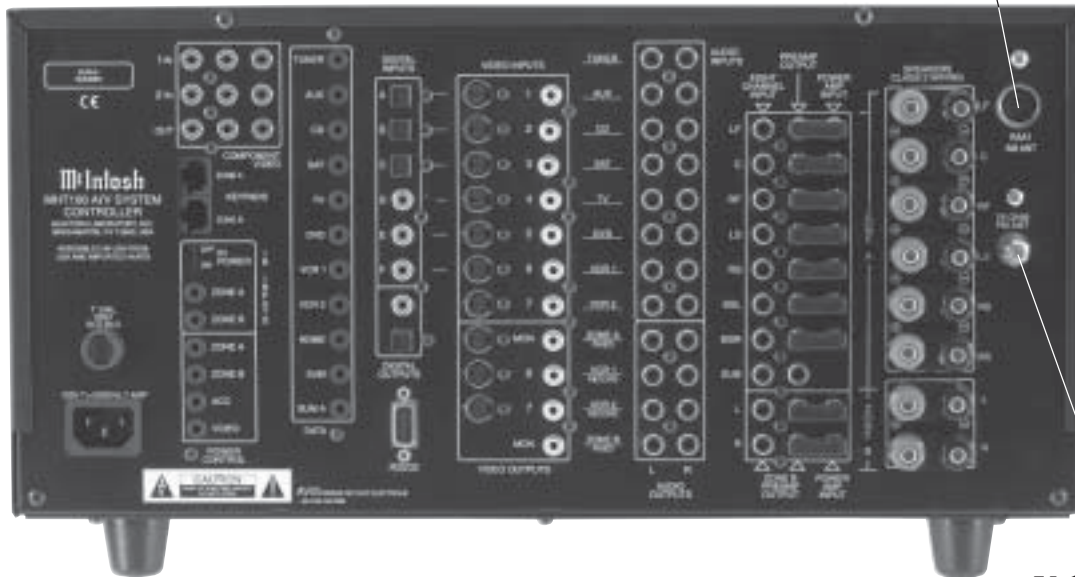

75ohm FM ANT (Antenna) connects to an external FM antenna or cable

### How to Connect Antenna Components

1. Connect the Remote AM antenna by plugging the DIN connector of the supplied 3 conductor cable into the AM ANT, DIN socket on the back panel of the MHT100.

*Note: If a longer length cable needs to be used between the MHT100 and the RAA1 use a 2 conductor shielded cable. Refer to page 6 for additional connection information.*

2. Connect a 75 ohm coax cable from an FM antenna or cable system to the MHT100, 75 ohm FM ANT connector.

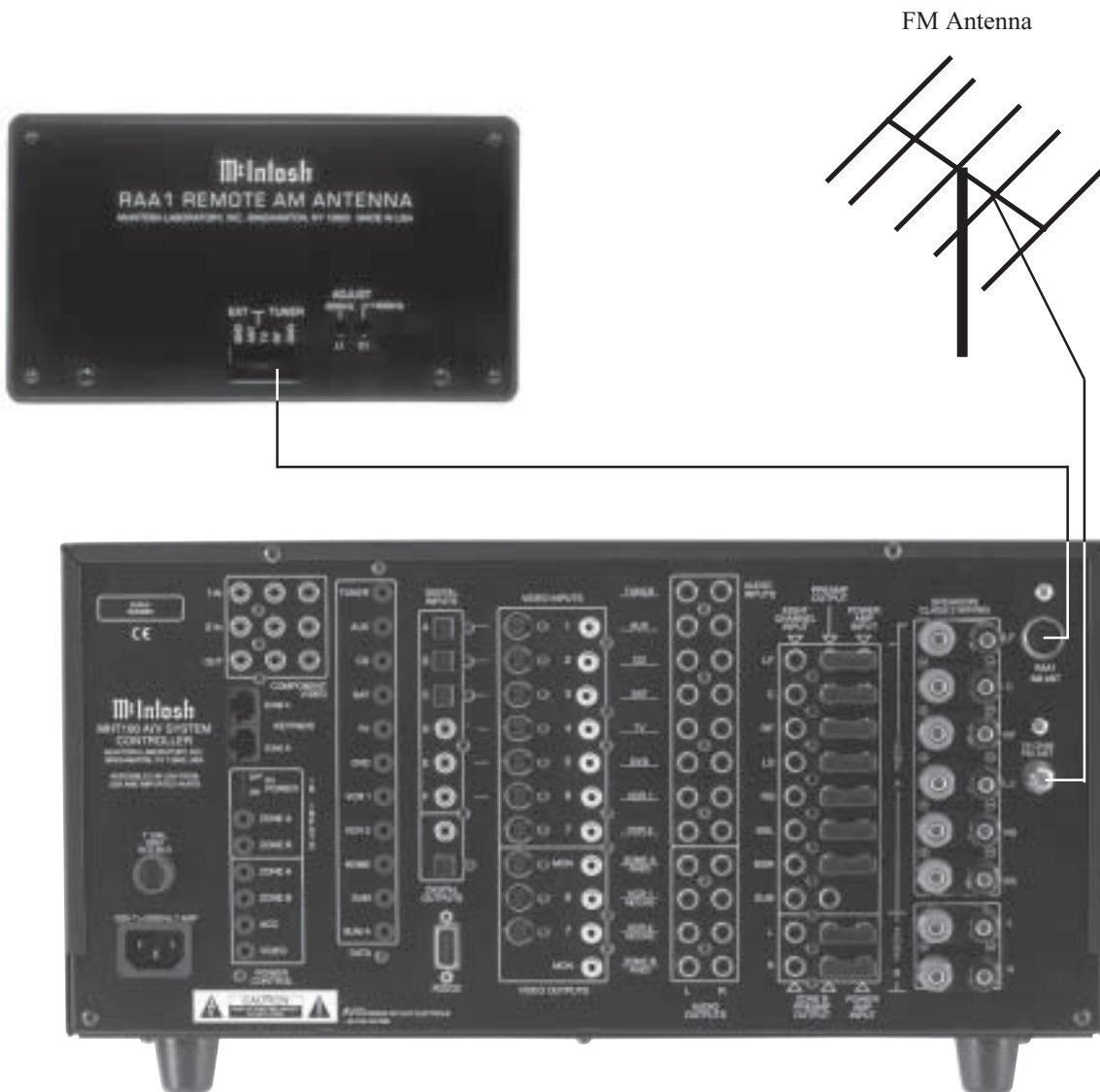

## How to Assign the Tuner Presets

The MHT100 Setup Mode Tuner Presets allow for the pre-setting into memory 9 FM and 9 AM Radio Stations for fast recall at any time. In addition, any preset can have a unique name assigned to it. When the preset station is recalled, the Front Panel Alphanumeric Display will show the name instead of the station's frequency.

*Note: The Tuner Setup Mode is applicable only for the internal Tuner Module.*

1. Press and hold the Front Panel SETUP Push-button approximately three seconds to enter the Setup Mode. The word SETUP will appear on the MHT100 Front Panel Display and the MAIN SYSTEM SETUP Menu will appear on the Monitor/TV screen. Refer to figure 63.

2. Using the Up▲ or Down▼ directional push-buttons select Tuner Presets on the On-Screen Menu, followed by the SELECT Push-button on the Remote Control.

*Note: Follow the steps below for each Broadcast Station Preset you wish to enter into memory.*

3. Using the Up▲ or Down▼ directional push-buttons select Number 1 PRESET from the On-Screen Menu, followed by pressing the Left◀ or Right▶ directional push-buttons to select the desired Preset. Refer to figure 64.

*Note: The Presets will scroll through FM Preset 1 to 9 and then to AM Presets 1 to 9.*

### Tuning Mode

The MHT100 allows for selection of Broadcast Stations either by scrolling through the Presets that are stored in memory or Tuning Manually. This setting is used for both entering Presets and for actual operation using the Front Panel TRIM/TUNE Up▲ or Down▼ directional push-buttons.

4. Using the Up▲ or Down▼ directional push-buttons select Number 2 TUNE from the On-Screen Menu, followed by pressing the Left◀ or Right▶ directional push-buttons to select AUTOMatic (for selecting Preset Stations) or MANUAL (for Manually Tuning Up or Down the broadcast band, for selecting Stations).

*Note: The PRESET TUNING MODE setting of AUTO or MANUAL only needs to set for one of the 18 Presets, as it is a global setting effecting*

### Frequency

5. Using the Up▲ or Down▼ directional push-buttons select Number 3 FREQUENCY from the On-Screen Menu, followed by pressing the Left◀ or Right▶ directional push-buttons to select the Frequency of the Broadcast Station that you wish to enter into memory. Refer to figure 65.

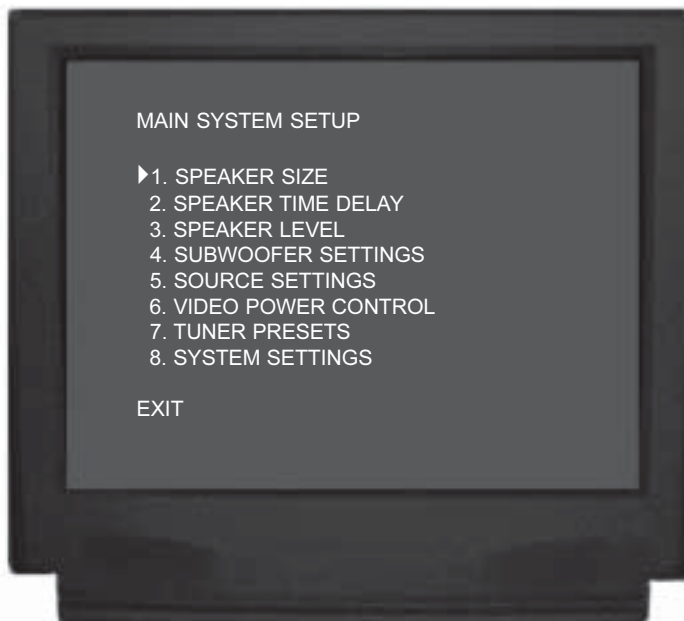

Figure 63

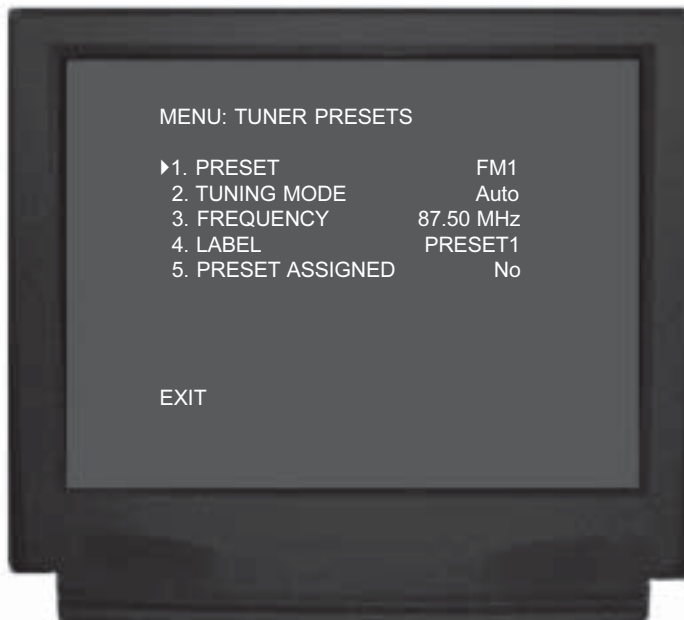

Figure 64



Figure 65

*Note: FM Broadcast Band Indications are in Megahertz. In the US and Canada the frequency changes are in 100kHz steps. The second digit to the right of the dot which displays a 0, is used for FM stations in various*

locations other than the US where stations change in 50Hz steps. AM Broadcast Band Indications are in Kiloherzt and change frequency in 10kHz steps.

### Label

6. Using Up▲ or Down▼ directional push-buttons select Number 4 LABEL followed by pressing the SELECT Push-button. The On-Screen Menu will now change, allowing the current Label Name to be altered. Refer to figure 66.
7. The On-Screen Display will show an arrow↑ underneath the left most character of the current LABEL Name. Press the Up▲ or Down▼ directional push-buttons to select the desired character from the available characters that include the alphabet, numbers and symbols.
8. To change the next character press the Right▶ directional push-button to move the arrow to change the next character. Press the Up▲ or Down▼ directional push-buttons again to select the desired character.
9. Repeat step 6 until the desired Preset Label Name is complete.  
*Note: The Input Title Name can be up to seven characters long.*
10. After the last character has been entered press the Left◀ or Right▶ directional push-buttons (or press the SELECT Push-button) until the TUNER PRESET Menu displays number 5, PRESET ASSIGNED.

### Preset Assigned

11. Using Up▲ or Down▼ directional push-buttons select Number 5 PRESET ASSIGNED from the On-Screen Menu, followed by pressing the Left◀ or Right▶ directional push-buttons to select Yes or No. If No is selected the MHT100 will skip that Preset, even though it has been entered. Refer to figure 67. Select EXIT on the menu and the MAIN SYSTEM SETUP Menu will reappear on the Monitor/TV screen.
12. Continue next to the SYSTEM SETUP on page 38 or if you do not wish to perform SYSTEM SETUP Adjustments at this time, proceed to the next step.
13. Continue next to the SYSTEM SETUP or you do not wish to perform SYSTEM SETUP Adjustments at this time, proceed to the next step.
14. Select EXIT from the MAIN SYSTEM SETUP Menu. If you are satisfied with the changes that you may have made, select YES to save those changes or NO not to save them. The MHT100 will then return to normal operation. Refer to figure 13 on page 25.



Figure 66

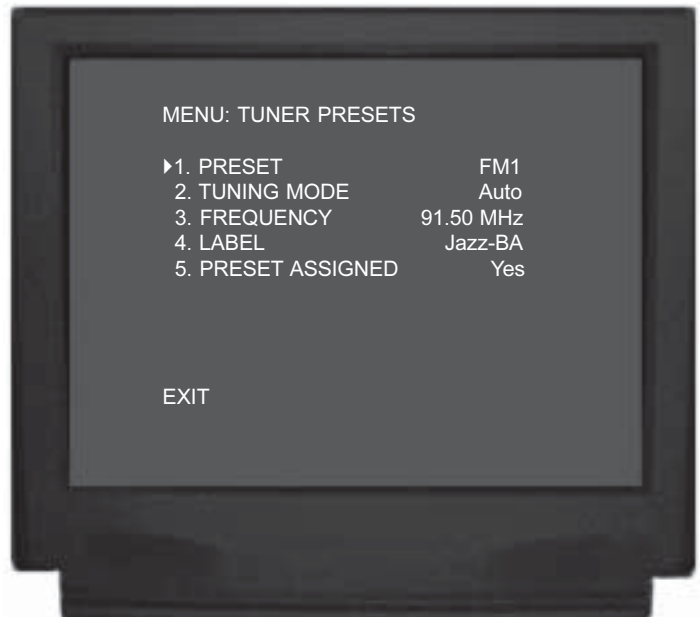

Figure 67

## How to Operate the Tuner

The McIntosh MHT100 TM1 AM/FM Tuner Module incorporates an advanced design AM/FM Tuner with many desirable performance features to enhance your enjoyment of radio broadcasts. There are several methods of tuning to an AM/FM Broadcast Station by using the Front Panel Trim/Tune Function and the Remote Control.

### Front Panel Tuning Functions

1. Select TUNER with the Front Panel INPUT Selector Switch. Refer to figures 68 and 69.



Figure 68

2. Rotate the TRIM SELECT Control to the TUNE Position and press the TRIM/TUNE Up▲ or Down▼ Push-button on the Front Panel until the desired AM or FM Broadcast Station Preset is selected.

*Note: If the TUNING MODE Setting in the Tuner Preset Setup is set to Manual instead of Automatic, the Front Panel TUNE Push-buttons will scan the entire FM and/or AM Broadcast Band and will function the same as the CHANNEL Push-buttons on the remote control. Refer to step 4 and 5 below for additional information.*

### Remote Control Tuning Functions

3. Select TUNER with the Remote Control TUNER Push-button. Refer to figures 68 and 70.
4. Select the desired Broadcast Band by pressing either the FM or AM Push-button.
5. Press and release the CHANNEL Up▲ or Down▼ Push-button on the Remote Control to find the next available station. Press and hold to move continuously

up or down the broadcast band. When a station is selected, the Front Panel Alphanumeric Display will indicate (from left to right) Station Signal Strength from 1 to 9, a dot if the Broadcast is Stereo, the AM/FM Station Frequency, AM or FM Broadcast Band and a Preset Number (if that station has been assigned a Preset).

6. Press and release the REVIEW Push-button to review all of the available presets stations, press the REVIEW Push-button a second time to stay on the current Preset.

*Note: FM Broadcast Band Indications are in Megahertz, in the US and Canada, and change frequency in 100kHz steps. The second digit to the right of the dot which displays a 0, is used for FM stations in various locations other than the US where stations change in 50Hz steps. AM Broadcast Band Indications are in Kiloherz and change frequency in 10kHz steps.*



Figure 70



Figure 69

### How to Optimize AM Reception

The McIntosh RAA1 Remote AM Antenna is designed to provide the best in AM Reception especially if the tuner or A/V unit is located in a noisy reception area. Locate the RAA1 away from all electronic and electrical interference sources. Rotate the antenna to reduce interference and receive maximum signal strength.

*Notes: The RAA1 Remote AM Antenna of the TMI has been factory adjusted for optimum reception in a typical urban location. If you wish to customize the antenna for the best possible performance in your location, have your dealer perform the two adjustment operations listed below.*

*An additional long wire AM antenna or external ground can be connected to the GND and ANT terminals if desired.*



Figure 71

1. Tune to a weak AM station near 600kHz on the AM band. Using an appropriate **NON - METALLIC**

tool, adjust the 600kHz Transformer L1 for maximum signal strength. Refer to figure 71.

2. Tune to a weak AM station near 1400kHz on the AM band. Using an appropriate **NON - METALLIC** tool, adjust the 1400kHz Trimmer Capacitor C1 for maximum signal strength. Refer to figure 71.
3. Repeat steps 1 and 2 until no further improvements can be obtained.

FM and AM Station Presets				
Preset Number	Frequency	City	Call Letters	Name
FM 1				
FM 2				
FM 3				
FM 4				
FM 5				
FM 6				
FM 7				
FM 8				
FM 9				
AM 1				
AM 2				
AM 3				
AM 4				
AM 5				
AM 6				
AM 7				
AM 8				
AM 9				



## FM Tuner Specifications

---

### Useable Sensitivity

14dBm which is 1.4uV across 75 ohms

### 50dB Quieting Sensitivity

Mono: 19dBm which is 2.4uV across 75 ohms

Stereo: 35dBm which is 15uV across 75 ohms

### Signal To Noise Ratio

Mono: 75dB

Stereo: 70dB

### Frequency Response

Mono: + 0, - 1dB from 20 to 15,000Hz

Stereo: + 0, - 1dB from 20 to 15,000Hz

### Harmonic Distortion

Mono: 0.3% at 100Hz

0.3% at 1,000Hz

0.3% at 10,000Hz

Stereo: 0.45% at 100Hz

0.45% at 1,000Hz

0.65% at 10,000Hz

### Intermodulation Distortion

Mono 0.25%

Stereo 0.45%

### Capture Ratio

1.2dB

### Alternate Channel Selectivity

75dB

### Spurious Response

100dB

### Image Response

75dB

### RF Intermodulation

65dB

### Stereo Separation

45dB at 100Hz

45dB at 1,000Hz

35dB at 10,000Hz

### SCA Rejection

65dB

## AM Tuner Specifications

---

### Sensitivity

20uV External Antenna Input

### Signal To Noise Ratio

48dB at 30% modulation

58dB at 100% modulation

### Harmonic Distortion

0.5% maximum at 50% modulation

### Frequency Response

50Hz to 6kHz NRSC

### Adjacent Channel Selectivity

45dB minimum IHF

### Image Rejection

65dB minimum from 540 to 1600kHz

### IF Rejection

80dB minimum

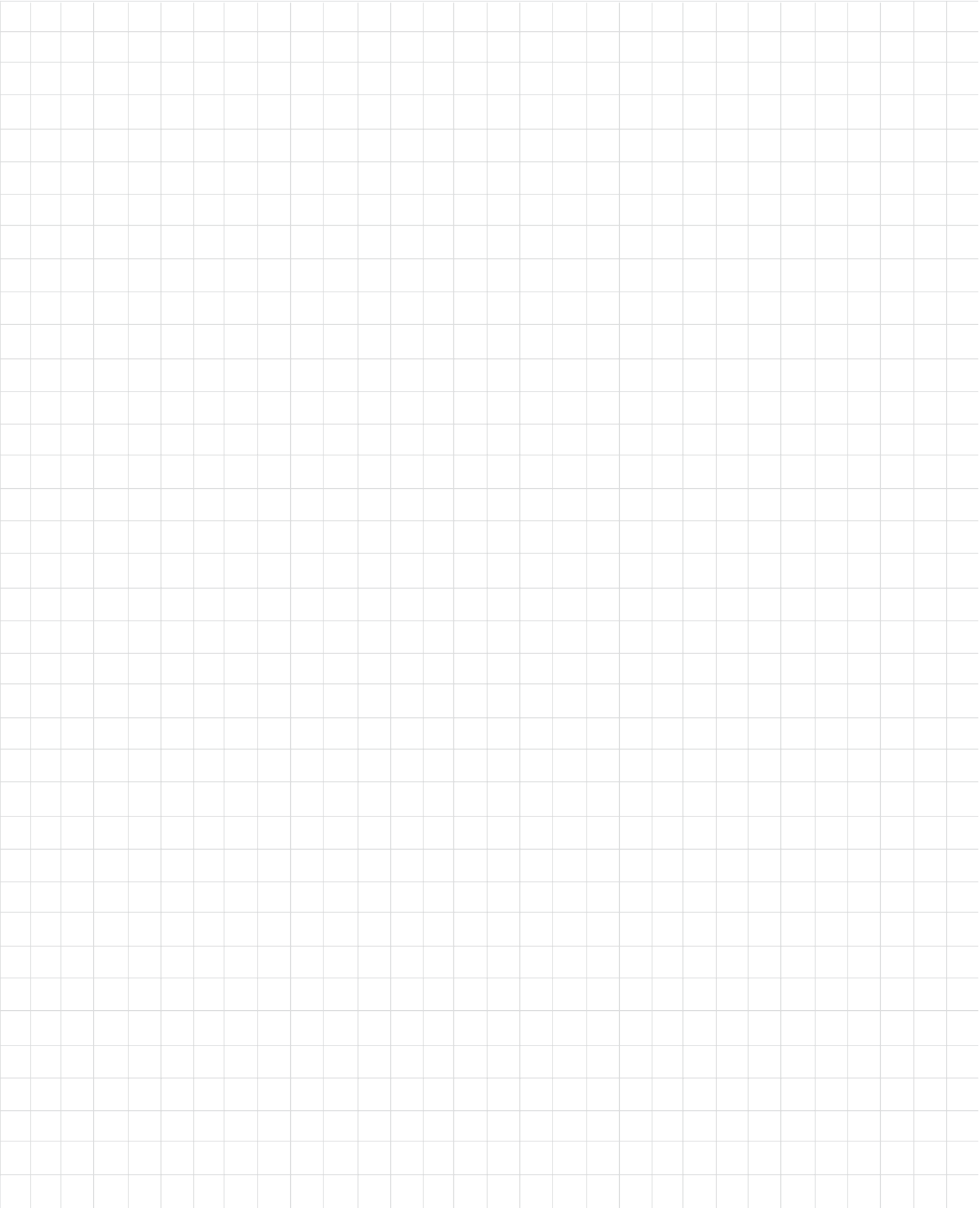

**Packing Instructions**

In the event it is necessary to repack the equipment for shipment, the equipment must be packed exactly as shown below. It is very important that the four plastic feet are attached to the bottom of the equipment. Two #10 x 2-1/4 inch screws and washers must be used to fasten the unit securely to the bottom pad and shipping skid. This will ensure the proper equipment location on the bottom pad. Failure to do this will result in shipping damage.

Use the original shipping carton and interior parts only if they are all in good serviceable condition. If a shipping carton or any of the interior part(s) are needed, please call or write Customer Service Department of McIntosh Laboratory. Please see the Part List for the correct part numbers.

Quantity	Part Number	Description
1	034158	Shipping carton only
2	034159	Foam end cap
1	034198	Inner carton top
1	034199	Inner carton bottom
1	033725	Top pad
1	034197	Bottom pad
1	034037	Inner carton pad
1	033160	Slit scored wrap
1	034196	Shipping skid
6	017218	Plastic foot
4	100159	#10-32 x 3/4" Machine screw
2	104083	#10 x 7/16" Flat washer
2	100169	#10 x 2-1/4" Wood screw
2	104033	#10 x 1-3/4" Flat washer

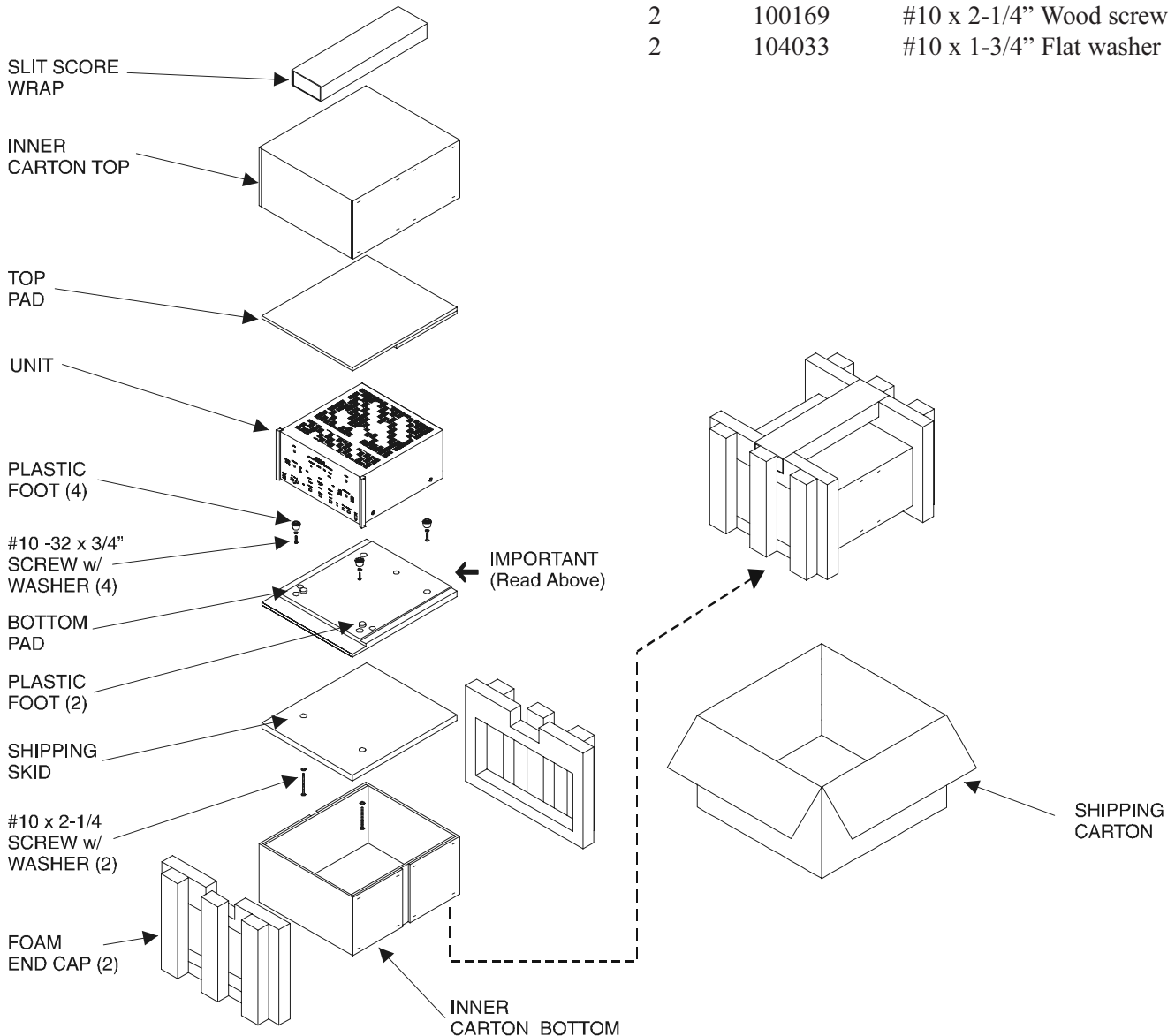

**McIntosh<sup>®</sup>**

McIntosh Laboratory, Inc.  
2 Chambers Street  
Binghamton, NY 13903